









Climate Control System

Special Tool(s)

	A/C Flush Adapter Kit 219-00074 or equivalent
	Flex Probe Kit NUD105-R025D or equivalent
	Fluke 77-IV Digital Multimeter FLU77-4 or equivalent
	Pressure Test Kit 014-R1072 or equivalent
	R-134a Manifold Gauge Set 176-R032A or equivalent
	Refrigerant Leak Detector 216-00001 or equivalent
	Test Light SGT27000 or equivalent 250-300 mA incandescent bulb test lamp
	Vehicle Communication Module (VCM) and Integrated Diagnostic System (IDS) software with appropriate hardware, or equivalent scan tool

Principles of Operation

The Refrigerant Cycle

During stabilized conditions (A/C system shutdown), the refrigerant pressures are equal throughout the system. When the A/C compressor is in operation, it increases pressure on the refrigerant vapor, raising its temperature. The high-pressure and high-temperature vapor is then released into the top of the A/C condenser core.

The A/C condenser, being close to ambient temperature, causes the refrigerant vapor to condense into a liquid when heat is removed from the refrigerant by ambient air passing over the fins and tubing. The now liquid refrigerant, still at high pressure, exits from the bottom of the A/C condenser and enters the inlet side of the A/C receiver/drier. The receiver/drier is designed to remove moisture from the refrigerant.

The outlet of the receiver/drier is connected to the Thermostatic Expansion Valve (TXV). The TXV provides the orifice which is the restriction in the refrigerant system and separates the high and low pressure sides of the A/C system. As the liquid refrigerant passes across this restriction, its pressure and boiling point are reduced.

The liquid refrigerant is now at its lowest pressure and temperature. As it passes through the A/C evaporator, it absorbs heat from the airflow passing over the plate/fin sections of the A/C evaporator. This addition of heat causes the refrigerant to boil (convert to gas). The now cooler air can no longer support the same humidity level of the warmer air and this excess moisture condenses on the exterior of the evaporator coils and fins and drains outside the vehicle.

The refrigerant cycle is now repeated with the A/C compressor again increasing the pressure and temperature of the refrigerant.

A thermistor which monitors the temperature of the air that has passed through the evaporator core controls A/C clutch cycling. If the temperature of the evaporator core discharge air is low enough to cause the condensed water vapor to freeze, the A/C clutch is disengaged by the vehicle PCM.

The high-side line pressure is also monitored so that A/C compressor operation will be interrupted if the system pressure becomes too high or is determined to be too low (low charge condition).

The A/C compressor relief valve will open and vent refrigerant to relieve unusually high system pressure.

Thermostatic Expansion Valve (TXV) Type Refrigerant System

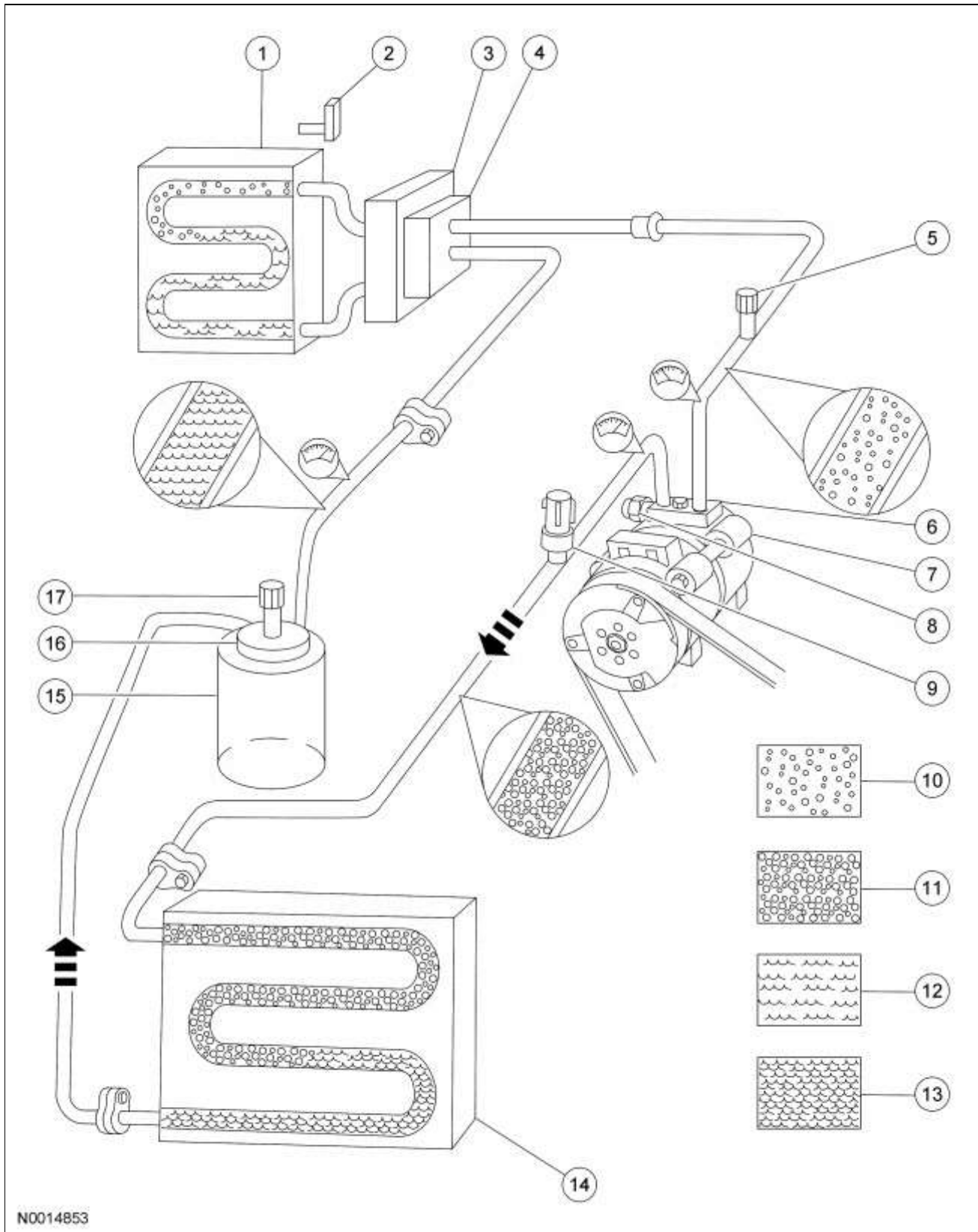

Item	Description
1	A/C evaporator core

Item	Description
2	A/C evaporator core outlet temperature thermistor
3	Thermostatic Expansion Valve (TXV)
4	Manifold and tube assembly — <u>TXV</u>
5	A/C charge valve port (low side)
6	Manifold and tube assembly — A/C compressor
7	A/C compressor
8	A/C pressure relief valve
9	A/C pressure transducer
10	Low-pressure vapor
11	High-pressure vapor
12	Low-pressure liquid
13	High-pressure liquid
14	A/C condenser core
15	A/C receiver/drier
16	Manifold and tube assembly — receiver/drier
17	A/C charge valve port (high side)

Inspection and Verification

1. Verify the customer's concern by operating the climate control system to duplicate the condition.
2. Inspect to determine if one of the following mechanical or electrical concerns apply:

Visual Inspection Chart

Mechanical	Electrical
<ul style="list-style-type: none"> • Loose, missing or damaged A/C compressor drive belt • Loose or disconnected A/C clutch • Broken or binding door/actuator • Broken or leaking refrigerant lines • Obstructed in-vehicle temperature sensor • Disconnected in-vehicle temperature aspirator hose 	<ul style="list-style-type: none"> • Battery Junction Box (BJB) fuse(s): <ul style="list-style-type: none"> ▪ 4 (30A) ▪ 25 (10A) ▪ 46 (5A) • Smart Junction Box (SJB) fuse(s): <ul style="list-style-type: none"> ▪ 15 (10A) ▪ 30 (5A) ▪ 45 (5A) • Blower motor inoperative • A/C compressor inoperative • Circuitry open/shorted • Disconnected electrical connectors • Cooling fan inoperative

3. If the inspection reveals obvious concerns that can be readily identified, repair as necessary.
4. **NOTE:** *Make sure to use the latest scan tool software release.*

If the cause is not visually evident, connect the scan tool to the Data Link Connector (DLC) .

5. **NOTE:** *The Vehicle Communication Module (VCM) LED prove-out confirms power and ground from the DLC are provided to the VCM .*

If the scan tool does not communicate with the VCM :

- check the VCM connection to the vehicle.
- check the scan tool connection to the VCM .
- refer to [Section 418-00](#), No Power To The Scan Tool, to diagnose no power to the scan tool.

6. If the scan tool does not communicate with the vehicle:

- verify the ignition key is in the ON position.
- verify the scan tool operation with a known good vehicle.
- refer to [Section 418-00](#) to diagnose no response from the PCM, HVAC module.

7. Carry out the network test.

- If the scan tool responds with no communication from one or more modules, refer to [Section 418-00](#).
- If the network test passes, retrieve and record the Continuous Memory Diagnostic Trouble Codes (CMDTCs)

8. Clear the continuous DTCs and carry out the self-test diagnostics from the PCM or HVAC module.

9. **NOTE:** *Some PCM DTCs may inhibit A/C operation. If any PCM DTCs are retrieved, diagnose those first. Refer to the PCM DTC Chart.*

If the HVAC DTCs retrieved are related to the concern, go to the HVAC Module DTC Chart. If the PCM DTCs retrieved are related to the concern, go to the PCM DTC Chart. For all other DTCs, refer to [Section 419-10](#).

10. If no DTCs related to the concern are retrieved, GO to [Symptom Chart — Climate Control Systems](#) or GO to [Symptom Chart — NVH](#).

DTC Charts

NOTE: *Network DTCs (U-codes) are often a result of intermittent concerns such as damaged wiring or low battery voltage occurrences. Additionally, vehicle repair procedures such as module reprogramming often set network DTCs. Replacing a module to resolve a network DTC is unlikely to resolve the concern. To prevent repeat network DTC concerns, inspect all network wiring, especially connectors. Test the vehicle battery, refer to [Section 414-01](#).*

PCM DTC Chart

DTC	Description	Action to Take
P0532	A/C Refrigerant Pressure Sensor A Circuit Low	GO to Pinpoint Test A.
P0533	A/C Refrigerant Pressure Sensor A Circuit High	GO to Pinpoint Test A.
P0645	Air Conditioning Clutch Relay (A/CCR) Control Circuit	GO to Pinpoint Test B.
P1464	A/C Demand Out Of Self Test Range	If the HVAC selector was not in the OFF position, place it in the OFF position, CLEAR the DTCs and REPEAT the self-test. If the DTC does not return, ignore the DTC and continue diagnostics. If the DTC returns, INSTALL a new HVAC module. CLEAR the DTCs and REPEAT the self-test.
All Other DTCs	—	REFER to Powertrain Control/Emissions Diagnosis (PC/ED) manual.

HVAC Module DTC Chart

NOTE: *This module utilizes a 5-character DTC followed by a 2-character failure-type code. The failure-type code provides information about specific fault conditions such as opens or shorts to ground. CMDTCs have an additional 2-character DTC status code suffix to assist in determining DTC history.*

NOTE: Some PCM DTCs may inhibit A/C operation. If any PCM DTCs are retrieved, diagnose those first. Refer to the PCM DTC Chart.

DTC	Description	Action to Take
B1030:11	Left Front Seat Heater: Circuit Short to Ground	REFER to Section 501-10 .
B1030:12	Left Front Seat Heater: Circuit Short to Battery	REFER to Section 501-10 .
B1030:13	Left Front Seat Heater: Circuit Open	REFER to Section 501-10 .
B1032:11	Right Front Seat Heater: Circuit Short to Ground	REFER to Section 501-10 .
B1032:12	Right Front Seat Heater: Circuit Short to Battery	REFER to Section 501-10 .
B1032:13	Right Front Seat Heater: Circuit Open	REFER to Section 501-10 .
B1081:00	Left Temperature Damper Motor: No Sub Type Information	GO to Pinpoint Test P.
B1081:11	Left Temperature Damper Motor: Circuit Short to Ground	GO to Pinpoint Test P.
B1081:12	Left Temperature Damper Motor: Circuit Short to Battery	GO to Pinpoint Test P.
B1082:00	Right Temperature Damper Motor: No Sub Type Information	GO to Pinpoint Test P.
B1082:11	Right Temperature Damper Motor: Circuit Short to Ground	GO to Pinpoint Test P.
B1082:12	Right Temperature Damper Motor: Circuit Short to Battery	GO to Pinpoint Test P.
B1083:00	Recirculation Damper Motor: No Sub Type Information	GO to Pinpoint Test J.
B1083:11	Recirculation Damper Motor: Circuit Short to Ground	GO to Pinpoint Test J.
B1083:12	Recirculation Damper Motor: Circuit Short to Battery	GO to Pinpoint Test J.
B1086:00	Air Distribution Damper Motor: No Sub Type Information	GO to Pinpoint Test K.
B1086:11	Air Distribution Damper Motor: Circuit Short to Ground	GO to Pinpoint Test K.
B1086:12	Air Distribution Damper Motor: Circuit Short to Battery	GO to Pinpoint Test K.

DTC	Description	Action to Take
B10AF:11	Blower Fan Relay: Circuit Short to Ground	GO to Pinpoint Test R.
B10AF:12	Blower Fan Relay: Circuit Short to Battery	GO to Pinpoint Test Q.
B10AF:13	Blower Fan Relay: Circuit Open	GO to Pinpoint Test Q.
B10B9:12	Blower Control: Circuit Short to Battery	GO to Pinpoint Test R.
B10B9:14	Blower Control: Circuit Short to Ground or Open	GO to Pinpoint Test Q.
B11E5:11	Left HVAC Damper Position Sensor: Circuit Short to Ground	GO to Pinpoint Test P.
B11E5:15	Left HVAC Damper Position Sensor: Circuit Short to Battery or Open	GO to Pinpoint Test P.
B11E6:11	Right HVAC Damper Position Sensor: Circuit Short to Ground	GO to Pinpoint Test P.
B11E6:15	Right HVAC Damper Position Sensor: Circuit Short to Battery or Open	GO to Pinpoint Test P.
B11E7:11	Air Distribution Damper Position Sensor: Circuit Short to Ground	GO to Pinpoint Test K.
B11E7:15	Air Distribution Damper Position Sensor: Circuit Short to Battery or Open	GO to Pinpoint Test K.
B125B:10	Air Distribution Damper "B" Motor: No Sub Type Information	GO to Pinpoint Test K.
B125B:11	Air Distribution Damper "B" Motor: Circuit Short to Ground	GO to Pinpoint Test K.
B125B:12	Air Distribution Damper "B" Motor: Circuit Short to Battery	GO to Pinpoint Test K.
B1A61:11	Cabin Temperature Sensor: Circuit Short to Ground	GO to Pinpoint Test D.
B1A61:15	Cabin Temperature Sensor: Circuit Short to Battery or Open	GO to Pinpoint Test D.
B1A63:11	Right Solar Sensor: Circuit Short to Ground	GO to Pinpoint Test F.
B1A63:15	Right Solar Sensor: Circuit Short to Battery or Open	GO to Pinpoint Test F.
B1A64:11	Left Solar Sensor: Circuit Short to Ground	GO to Pinpoint Test F.
B1A64:15	Left Solar Sensor: Circuit Short to Battery or Open	GO to Pinpoint Test F.
B1A68:11	Ambient Temperature Sensor: Circuit Short to	GO to Pinpoint Test E.

DTC	Description	Action to Take
	Ground	
B1A68:15	Ambient Temperature Sensor: Circuit Short to Battery or Open	GO to Pinpoint Test E.
B1B71:11	Evaporator Temperature Sensor: Circuit Short to Ground	GO to Pinpoint Test G.
B1B71:15	Evaporator Temperature Sensor: Circuit Short to Battery or Open	GO to Pinpoint Test G.
B1C83:11	Rear Defog Relay: Circuit Short to Ground	REFER to Section 501-11.
B1C83:12	Rear Defog Relay: Circuit Short to Battery	REFER to Section 501-11.
B1C83:13	Rear Defog Relay: Circuit Open	REFER to Section 501-11.
C1B14:11	Sensor Supply Voltage A: Circuit Short to Ground	GO to Pinpoint Test C.
C1B14:12	Sensor Supply Voltage A: Circuit Short to Battery	GO to Pinpoint Test C.
U0140:87	Lost Communication With Body Control Module: Missing Message	This DTC can set because the Smart Junction Box (SJB) is unable to communicate with the HVAC module over the Controller Area Network (CAN) bus. CARRY OUT a self-test of the SJB . If the scan tool indicates that the SJB is not responding, REFER to Section 418-00 to diagnose the network communication concern. If SJB DTCs are present, REFER to Section 419-10.
U0155:87	Lost Communication With Instrument Panel Cluster (IPC) Module: Missing Message	This DTC can set because the IPC is unable to communicate with the HVAC module over the Controller Area Network (CAN) bus. CARRY OUT a self-test of the IPC . If the scan tool indicates that the IPC is not responding, REFER to Section 418-00 to diagnose the network communication concern. If IPC DTCs are present, REFER to Section 419-10.
U0163:87	Lost Communication With Navigation Control Module: Missing Message	This DTC can set because the Audio Front Control Module (ACM) is unable to communicate with the HVAC module over the Controller Area Network (CAN) bus. CARRY OUT a self-test of the ACM . If the scan tool indicates that the ACM is not responding, REFER to Section 418-00 to diagnose the network communication concern. If ACM DTCs are present, REFER to Section 419-10.
U0256:87	Lost Communication With Front Controls Interface Module (FCIM) "A": Missing Message	This DTC can set because the FCIM is unable to communicate with the HVAC module over the Controller Area Network (CAN) bus. CARRY OUT a self-test of the FCIM . If the scan tool indicates that the FCIM is not responding, REFER to Section 418-00 to diagnose the network communication concern. If FCIM DTCs are present, REFER to Section 419-10.
U0422:68	Invalid Data Received From Body Control Module: Event Information	This DTC can set due to a fault in the Smart Junction Box (SJB) . CARRY OUT a self-test of the SJB . If the scan tool indicates that the SJB is not responding, REFER to Section 418-00 to diagnose the network communication concern. If SJB DTCs are present, REFER to Section 419-10.
U0423:68	Invalid Data Received From Instrument Panel Cluster Control Module: Event Information	This DTC can set because the Instrument Panel Cluster (IPC) . CARRY OUT a self-test of the IPC . If the scan tool indicates that the IPC is not responding, REFER to Section 418-00 to diagnose the network communication concern. If IPC DTCs are present, REFER to Section 419-10.
U0464:68	Invalid Data Received From Navigation Control Module: Event Information	This DTC can set due to a fault in the Audio Front Control Module (ACM) . CARRY OUT a self-test of the ACM . If the scan tool indicates that the ACM is not responding, REFER to Section 418-00 to diagnose the network communication concern. If ACM DTCs are present, REFER to Section 415-00 to diagnose the ACM fault.
U0557:68	Invalid Data Received From Front Controls Interface	This DTC can set due to a fault in the FCIM . CARRY OUT a self-test of the FCIM . If the scan tool indicates that the FCIM is not responding, REFER to

DTC	Description	Action to Take
	Module (FCIM) "A": Event Information	Section 418-00 to diagnose the network communication concern. If FCIM DTCs are present, REFER to Section 415-00 to diagnose the FCIM fault.
U3000:41	Control Module: General Checksum Failure	INSTALL a new HVAC module. REFER to Section 412-01 .
U3003:16	Battery Voltage: Circuit Voltage Below Threshold	GO to Pinpoint Test H.
U3003:17	Battery Voltage: Circuit Voltage Above Threshold	GO to Pinpoint Test H.
All Other DTCs	—	REFER to the Master DTC Chart in Section 419-10 .

Symptom Chart — Climate Control Systems

Symptom Chart — Climate Control Systems

Condition	Possible Causes	Action
NOTE: Some PCM DTCs may inhibit A/C operation. If any PCM DTCs are retrieved, diagnose those first. Refer to Powertrain Control/Emissions Diagnosis (PC/ED) manual.		
<ul style="list-style-type: none"> No communication with the HVAC module 	<ul style="list-style-type: none"> Fuse(s) Circuitry open HVAC module communication network 	<ul style="list-style-type: none"> REFER to Section 418-00.
<ul style="list-style-type: none"> Unable to duplicate the customer concern and no DTCs present 	<ul style="list-style-type: none"> HVAC system and/or related components 	<ul style="list-style-type: none"> GO to Pinpoint Test I.
<ul style="list-style-type: none"> Incorrect/erratic function in AUTO mode 	<ul style="list-style-type: none"> Circuitry open/shorted In-vehicle temperature sensor HVAC module 	<ul style="list-style-type: none"> GO to Pinpoint Test S.
<ul style="list-style-type: none"> Reduced outlet airflow 	<ul style="list-style-type: none"> Circuitry short A/C compressor clutch air gap A/C pressure transducer Evaporator discharge air temperature sensor A/C clutch relay Blower motor Blower motor control PCM 	<ul style="list-style-type: none"> If the A/C compressor does not cycle, GO to Pinpoint Test N. If the A/C compressor cycles normally, GO to Pinpoint Test R.
<ul style="list-style-type: none"> The air inlet door is inoperative 	<ul style="list-style-type: none"> Circuitry open/shorted Air inlet mode door actuator Air inlet door binding or stuck HVAC module 	<ul style="list-style-type: none"> GO to Pinpoint Test J.
<ul style="list-style-type: none"> Incorrect/erratic direction of airflow from outlets 	<ul style="list-style-type: none"> Circuitry open/shorted Mode door actuator(s) 	<ul style="list-style-type: none"> GO to Pinpoint Test K.

	<ul style="list-style-type: none"> • Mode door(s) binding or stuck • HVAC module 	
<ul style="list-style-type: none"> • Insufficient, erratic or no heat 	<ul style="list-style-type: none"> • Low engine coolant level • Plugged or partially plugged heater core • Temperature blend door(s) binding or stuck • Temperature blend door actuator(s) 	<ul style="list-style-type: none"> • GO to Pinpoint Test L.
<ul style="list-style-type: none"> • The air conditioning (A/C) is inoperative 	<ul style="list-style-type: none"> • Fuse(s) • Circuitry open • A/C system discharged/low charge • PCM • HVAC module • A/C clutch relay • A/C compressor clutch air gap • A/C pressure transducer • Evaporator discharge air temperature sensor • A/C compressor clutch field coil 	<ul style="list-style-type: none"> • GO to Pinpoint Test M.
<ul style="list-style-type: none"> • The air conditioning (A/C) is always on — A/C compressor does not cycle 	<ul style="list-style-type: none"> • Circuitry shorted • PCM • A/C clutch relay • A/C compressor clutch air gap • Evaporator discharge air temperature sensor 	<ul style="list-style-type: none"> • GO to Pinpoint Test N.
<ul style="list-style-type: none"> • The air conditioning (A/C) is always on — A/C mode always commanded ON 	<ul style="list-style-type: none"> • Circuitry shorted • PCM • HVAC module 	<ul style="list-style-type: none"> • GO to Pinpoint Test O.
<ul style="list-style-type: none"> • Temperature control is inoperative/does not operate correctly 	<ul style="list-style-type: none"> • Circuitry open/shorted • HVAC module • Temperature blend door is binding or stuck • Temperature blend door actuator 	<ul style="list-style-type: none"> • GO to Pinpoint Test P.
<ul style="list-style-type: none"> • The blower motor is inoperative 	<ul style="list-style-type: none"> • Fuse(s) • Circuitry short/open • Blower motor relay • Blower motor • HVAC module • Blower motor speed control 	<ul style="list-style-type: none"> • GO to Pinpoint Test Q.
<ul style="list-style-type: none"> • The blower motor does not operate correctly 	<ul style="list-style-type: none"> • Circuitry open/shorted • Blower motor speed control 	<ul style="list-style-type: none"> • GO to Pinpoint Test R.

	<ul style="list-style-type: none"> • HVAC module 	
<ul style="list-style-type: none"> • The temperature set point does not repeat after turning the ignition switch OFF 	<ul style="list-style-type: none"> • HVAC module 	<ul style="list-style-type: none"> • INSTALL a new HVAC module. REFER to Section 412-01.
<ul style="list-style-type: none"> • Inaccurate external temperature display 	<ul style="list-style-type: none"> • HVAC module • Ambient temperature sensor 	<ul style="list-style-type: none"> • GO to Pinpoint Test E.
<ul style="list-style-type: none"> • A/C pressure relief valve discharging 	<ul style="list-style-type: none"> • High system pressure • A/C pressure relief valve 	<ul style="list-style-type: none"> • CHECK the high side system pressure. If the pressure is below the A/C pressure relief valve open pressure, REPLACE the A/C pressure relief valve. If the system pressure is above the A/C pressure relief valve open pressure, REPAIR the system for a restriction.

Symptom Chart — NVH

Symptom Chart — NVH

Condition	Possible Causes	Action
<p>NOTE: NVH symptoms will be identified using the diagnostic tools that are available. For a list of these tools, an explanation of their uses and a glossary of common terms, refer to Section 100-04. Since it is possible any one of multiple systems may be the cause of a symptom, it may be necessary to use a process of elimination type of diagnostic approach to pinpoint the responsible system. If this is not the causal system for the symptom, refer back to Section 100-04 for the next likely system and continue diagnosis.</p>		
<ul style="list-style-type: none"> • Noisy A/C compressor 	<ul style="list-style-type: none"> • A/C compressor clutch air gap out of specification • A/C compressor pulley bearing worn • A/C compressor bearing worn 	<ul style="list-style-type: none"> • CHECK and ADJUST the A/C compressor clutch gap if necessary. REFER to Air Conditioning (A/C) Clutch Air Gap Adjustment in this section. TEST the system for normal operation. • If the A/C compressor clutch gap is OK, INSTALL an A/C compressor clutch. REFER to Section 412-01. TEST the system for normal operation. • INSPECT the A/C compressor pulley bearing for roughness. If bearing roughness is found, INSTALL an A/C compressor pulley. REFER to Section 412-01. TEST the system for normal operation. • INSPECT the A/C compressor bearing for roughness. If bearing roughness is found, INSTALL an A/C compressor. REFER to Section 412-01. TEST the system for normal operation.

Pinpoint Tests

Pinpoint Test A: DTC P0532 or P0533

Refer to Wiring Diagrams Cell [54](#) , Manual Climate Control System for schematic and connector information.

Refer to Wiring Diagrams Cell [55](#) , Automatic Climate Control System for schematic and connector information.

Normal Operation

Under normal operation, the A/C pressure transducer receives a ground from the PCM. A 5-volt reference voltage is supplied to the A/C pressure transducer from the PCM. The A/C pressure transducer then sends a voltage to the PCM to indicate the A/C pressure.

- DTC P0532 (A/C Refrigerant Pressure Sensor A Circuit Low) — The A/C pressure transducer inputs a feedback voltage to the PCM. This DTC will set if the feedback voltage is less than 0.26 volts for at least 2 seconds and the ambient air temperature is greater than 0°C (32°F).
- DTC P0533 (A/C Refrigerant Pressure Sensor A Circuit High) — The A/C pressure transducer inputs a feedback voltage to the PCM. This DTC will set if the feedback voltage is greater than 4.95 volts for at least 2 seconds and

the ambient air temperature is greater than 0°C (32°F).

This pinpoint test is intended to diagnose the following:

- Wiring, terminals or connectors
- A/C pressure transducer
- PCM

PINPOINT TEST A : DTC P0532 OR P0533

A1 CHECK THE PCM OUTPUT VOLTAGE

- Ignition OFF.
- Disconnect: A/C Pressure Transducer C1260 .
- Ignition ON.
- Measure the voltage between ground and A/C pressure transducer [C1260](#) Pin 3, circuit LE423 (GN/VT), harness side.

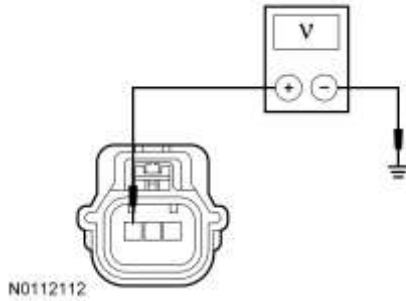

Is the voltage between 4.7 and 5.1 volts?

Yes	GO to A2 .
No	If the voltage is below 4.7 volts, REPAIR circuit LE423 (GN/VT) for an open or high resistance. CLEAR the DTCs. REPEAT the self-test. TEST the system for normal operation. If the voltage is greater than 5.1 volts REPAIR circuit LE423 (GN/VT) for a short to voltage. CLEAR the DTCs. REPEAT the self-test. TEST the system for normal operation.

A2 CHECK THE PCM SENSOR GROUND

- Measure the voltage between A/C pressure transducer [C1260](#) Pin 1, circuit RE405 (GN/WH), harness side and A/C pressure transducer [C1260](#) Pin 3, circuit LE423 (GN/VT), harness side.

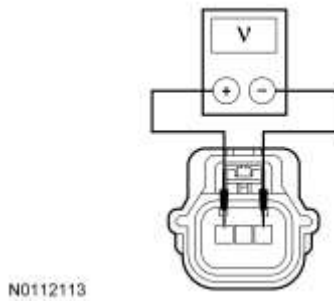

Is the voltage between 4.7 and 5.1 volts?

Yes	If diagnosing DTC P0532 , GO to A3 . If diagnosing DTC P0533 , GO to A5 .
No	REPAIR circuit RE405 (GN/WH) for an open. CLEAR the DTCs. REPEAT the self-test. TEST the system for normal operation.

A3 CHECK THE A/C PRESSURE SENSOR (ACP_V) PCM PID WITH THE A/C PRESSURE TRANSDUCER DISCONNECTED

- Enter the following diagnostic mode on the scan tool: ACP_V PCM PID .
- Observing the ACP_V PCM PID voltage.

Does the ACP_V PCM PID voltage read greater than 4 volts?

Yes	INSTALL a new A/C pressure transducer. CLEAR the DTCs. REPEAT the self-test. TEST the system for normal operation.
No	GO to A4 .

A4 CHECK CIRCUIT VH433 (VT/OG) FOR A SHORT TO GROUND

- Ignition OFF.
- Disconnect: (5.0L, 5.4L) PCM C175B .
- Disconnect: (3.7L) PCM C1381B .
- Measure the resistance between ground and A/C pressure transducer [C1260](#) Pin 2, circuit VH433 (VT/OG), harness side.

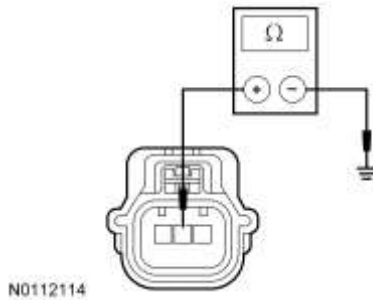

Is the resistance greater than 10,000 ohms?

Yes	GO to A5 .
No	REPAIR circuit VH433 (VT/OG) for a short to ground. CLEAR the DTCs. REPEAT the self-test. TEST the system for normal operation.

A5 CHECK CIRCUIT VH433 (VT/OG) FOR AN OPEN

- Measure the resistance between A/C pressure transducer [C1260](#) Pin 2, circuit VH433 (VT/OG), harness side and:
 - For 5.0L and 5.4L, PCM [C175B](#) Pin 31, circuit VH433 (VT/OG), harness side.
 - For 3.7L, PCM [C1381B](#) Pin 31, circuit VH433 (VT/OG), harness side.

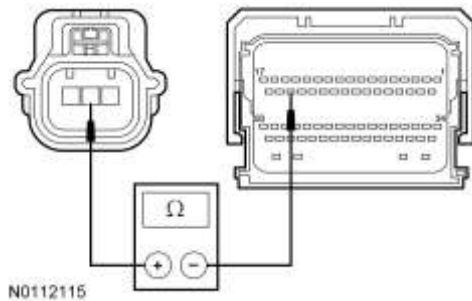

Is the resistance less than 5 ohms?

Yes	GO to A8 .
------------	----------------------------

No	REPAIR circuit VH433 (VT/OG) for an open. CLEAR the DTCs. REPEAT the self-test. TEST the system for normal operation.
-----------	---

A6 CHECK THE A/C PRESSURE SENSOR (ACP_V) PCM PID WITH THE A/C PRESSURE TRANSDUCER SHORTED

- Enter the following diagnostic mode on the scan tool: ACP_V PCM PID .
- While observing the ACP_V PCM PID, connect a fused jumper between A/C pressure transducer [C1260](#) Pin 2, circuit VH433 (VT/OG), harness side and A/C pressure transducer [C1260](#) Pin 1, circuit RE405 (GN/WH), harness side.

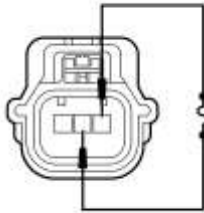

N0112116

Does the ACP_V PCM PID voltage read less than 4.9 volts?

Yes	INSTALL a new A/C pressure transducer. CLEAR the DTCs. REPEAT the self-test. TEST the system for normal operation.
------------	--

No	GO to A7 .
-----------	----------------------------

A7 CHECK CIRCUIT VH433 (VT/OG) FOR A SHORT TO VOLTAGE

- Ignition OFF.
- Disconnect: (5.0L, 5.4L) PCM C175B .
- Disconnect: (3.7L) PCM C1381B .
- Ignition ON.
- Measure the voltage between ground and A/C pressure transducer [C1260](#) Pin 2, circuit VH433 (VT/OG), harness side.

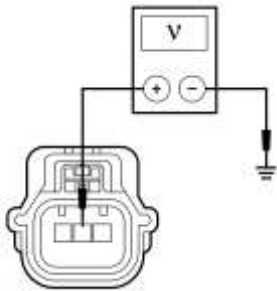

N0112117

Is any voltage present?

Yes	REPAIR circuit VH433 (VT/OG) for a short to voltage. CLEAR the DTCs. REPEAT the self-test. TEST the system for normal operation.
------------	--

No	GO to A9 .
-----------	----------------------------

A8 CHECK CIRCUIT VH433 (VT/OG) FOR A SHORT TO CIRCUIT RE405 (GN/WH)

- Ignition OFF.

- Measure the resistance between A/C pressure transducer [C1260](#) Pin 2, circuit VH433 (VT/OG), harness side and A/C pressure transducer [C1260](#) Pin 1, circuit RE405 (GN/WH), harness side.

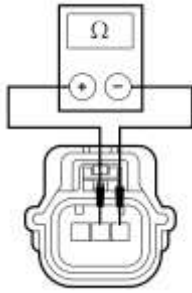

N0112118

Is the resistance greater than 10,000 ohms?

Yes	GO to A10 .
No	REPAIR circuit VH433 (VT/OG) for a short to circuit RE405 (GN/WH). CLEAR the DTCs. REPEAT the self-test. TEST the system for normal operation.

A9 CHECK CIRCUIT VH433 (VT/OG) FOR A SHORT TO CIRCUIT LE423 (GN/VT)

- Ignition OFF.
- Measure the resistance between A/C pressure transducer [C1260](#) Pin 2, circuit VH433 (VT/OG), harness side and A/C pressure transducer [C1260](#) Pin 3, circuit LE423 (GN/VT), harness side.

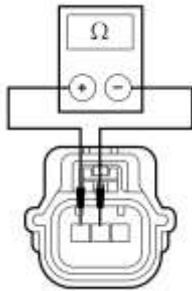

N0112119

Is the resistance greater than 10,000 ohms?

Yes	GO to A10 .
No	REPAIR circuit VH433 (VT/OG) for a short to circuit LE423 (GN/VT). CLEAR the DTCs. REPEAT the self-test. TEST the system for normal operation.

A10 CHECK THE PCM CONNECTION

- Disconnect all the PCM connectors.
- Inspect the HVAC module connectors for:
 - corrosion.
 - pushed-out terminals.
 - damaged terminals.
- Connect and correctly seat all the PCM connectors.
- Clear the DTCs.
- Operate the system and verify the concern is still present.

Is the concern still present?

Yes	INSTALL a new PCM. TEST the system for normal operation.
------------	--

No	The system is operating correctly at this time. The concern may have been caused by a loose or corroded connector.
-----------	--

Pinpoint Test B: DTC P0645

Refer to Wiring Diagrams Cell [54](#) , Manual Climate Control System for schematic and connector information.

Refer to Wiring Diagrams Cell [55](#) , Automatic Climate Control System for schematic and connector information.

Normal Operation

Under normal operation, voltage is provided to the A/C clutch relay coil. When A/C is requested and A/C line pressures allow, a ground is provided to the A/C clutch relay coil from the PCM, energizing the A/C clutch relay.

- DTC P0645 (A/C Clutch Relay Control Circuit) — The DTC sets when the relay circuit is OFF and no voltage is detected on the relay circuit. The PCM expects to detect voltage coming through the relay coil to the relay circuit when it is not grounding it.

This pinpoint test is intended to diagnose the following:

- Wiring, terminals or connectors
- A/C clutch relay
- PCM

PINPOINT TEST B : DTC P0645

B1 CHECK THE VOLTAGE TO THE A/C CLUTCH RELAY

- Ignition OFF.
- Disconnect: A/C Clutch Relay .
- Ignition ON.
- Measure the voltage between ground and the A/C clutch relay socket, circuit CBB46 (WH/BU).

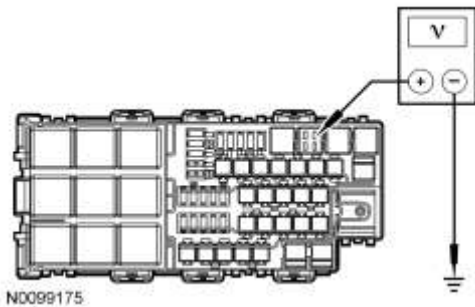

Is the voltage greater than 10 volts?

Yes	CARRY OUT the A/C clutch relay component test. Refer to Wiring Diagrams Cell 149 for component testing. If the relay tests OK, GO to B2 .
No	REPAIR circuit CBB46 (WH/BU) for an open. CLEAR the DTCs. REPEAT the self-test. TEST the system for normal operation.

B2 CHECK CIRCUIT CH302 (WH/BN) FOR A SHORT TO VOLTAGE

- Ignition OFF.
- Disconnect: PCM C175B .
- Ignition ON.

- Measure the voltage between ground and:
 - For 5.0L and 5.4L, PCM [C175B](#) Pin 12, circuit CH302 (WH/BN), harness side.
 - For 3.7L, PCM [C1381B](#) Pin 12, circuit CH302 (WH/BN), harness side.

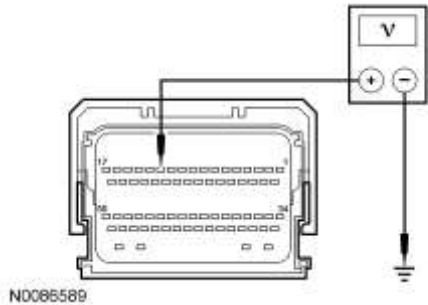

Is any voltage present?

Yes	REPAIR circuit CH302 (WH/BN) for a short to voltage. CLEAR the DTCs. REPEAT the self-test. TEST the system for normal operation.
No	GO to B3 .

B3 CHECK CIRCUIT CH302 (WH/BN) FOR A SHORT TO GROUND

- Ignition OFF.
- Measure the resistance between ground and:
 - For 5.0L and 5.4L, PCM [C175B](#) Pin 12, circuit CH302 (WH/BN), harness side.
 - For 3.7L, PCM [C1381B](#) Pin 12, circuit CH302 (WH/BN), harness side.

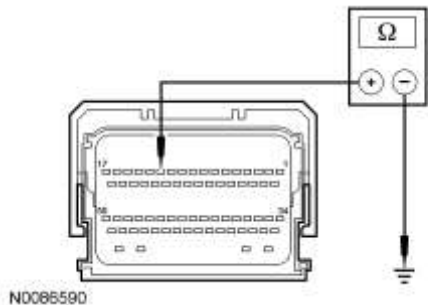

Is the resistance greater than 10,000 ohms?

Yes	GO to B4 .
No	REPAIR circuit CH302 (WH/BN) for a short to ground. CLEAR the DTCs. REPEAT the self-test. TEST the system for normal operation.

B4 CHECK CIRCUIT CH302 (WH/BN) FOR AN OPEN

- Measure the resistance between A/C clutch relay socket, circuit CH302 (WH/BN) and:
 - For 5.0L and 5.4L, PCM [C175B](#) Pin 12, circuit CH302 (WH/BN), harness side.
 - For 3.7L, PCM [C1381B](#) Pin 12, circuit CH302 (WH/BN), harness side.

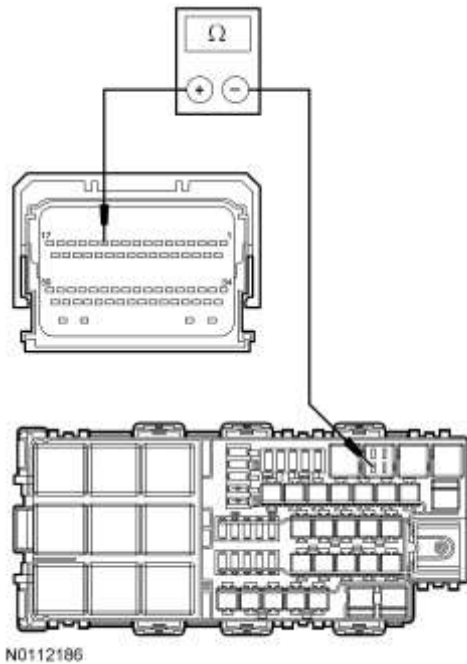

Is the resistance less than 5 ohms?

Yes	GO to B5 .
No	REPAIR circuit CH302 (WH/BN) for an open. CLEAR the DTCs. REPEAT the self-test. TEST the system for normal operation.

B5 CHECK THE PCM CONNECTION

- Disconnect all the PCM connectors.
- Inspect the HVAC module connectors for:
 - corrosion.
 - pushed-out terminals.
 - damaged terminals.
- Connect and correctly seat all the PCM connectors.
- Clear the DTCs.
- Operate the system and verify the concern is still present.

Is the concern still present?

Yes	INSTALL a new PCM. TEST the system for normal operation.
No	The system is operating correctly at this time. The concern may have been caused by a loose or corroded connector.

Pinpoint Test C: DTCs C1B14:11 and C1B14:12

Refer to Wiring Diagrams Cell [54](#) , Manual Climate Control System for schematic and connector information.

Refer to Wiring Diagrams Cell [55](#) , Automatic Climate Control System for schematic and connector information.

Normal Operation

Under normal operation, a 5-volt reference voltage is supplied to the sensors and actuators from the HVAC module.

- DTC C1B14:11 (Sensor Supply Voltage A: Circuit Short to Ground) — The module senses less than 0.1 volt on the sensor reference voltage circuit, indicating a short directly to ground.
- DTC C1B14:12 (Sensor Supply Voltage A: Circuit Short to Battery) — The module senses greater than 4.9 volts on the sensor reference voltage circuit, indicating a short directly to voltage.

This pinpoint test is intended to diagnose the following:

- Wiring, terminals or connectors
- HVAC module

PINPOINT TEST C : DTCS C1B14:11 AND C1B14:12

C1 CHECK THE SENSOR RESISTANCE

- Check for HVAC DTCs.

Is DTC C1B14:11 present?

Yes	GO to C2 .
No	GO to C4 .

C2 CHECK CIRCUIT LH111 (BN/WH) FOR A SHORT TO GROUND

- Ignition OFF.
- Disconnect: HVAC Module C294A .
- Disconnect: HVAC Module C294B .
- Measure the resistance between ground and HVAC module [C294A](#) Pin 3, circuit LH111 (BN/WH), harness side.

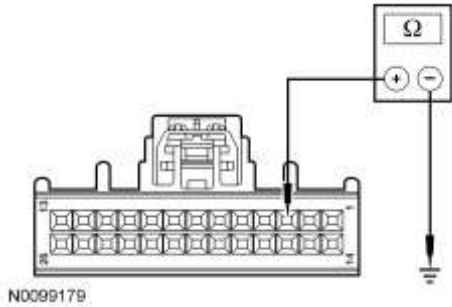

Is the resistance greater than 10,000 ohms?

Yes	GO to C3 .
No	REPAIR circuit LH111 (BN/WH) for a short to ground. CLEAR the DTCs. REPEAT the self-test. TEST the system for normal operation.

C3 CHECK CIRCUITS LH111 (BN/WH) AND RH111 (GY/BU) FOR A SHORT TOGETHER

- Measure the resistance between HVAC module [C294A](#) Pin 3, circuit LH111 (BN/WH), harness side and HVAC module [C294A](#) Pin 4, circuit RH111 (GY/BU), harness side.

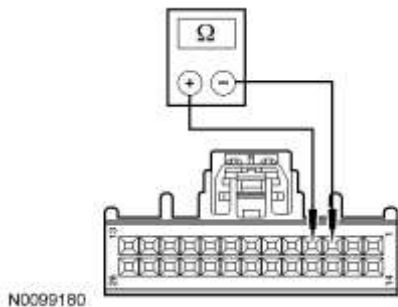

Is the resistance greater than 200 ohms?

Yes	GO to C5 .
No	REPAIR circuits LH111 (BN/WH) and RH111 (GY/BU) for a short together. CLEAR the DTCs. REPEAT the self-test. TEST the system for normal operation.

C4 CHECK CIRCUIT LH111 (BN/WH) FOR A SHORT TO VOLTAGE

- Ignition OFF.
- Disconnect: HVAC Module C294A .
- Disconnect: HVAC Module C294B .
- Ignition ON.
- Measure the voltage between ground and HVAC module [C294A](#) Pin 3, circuit LH111 (BN/WH), harness side.

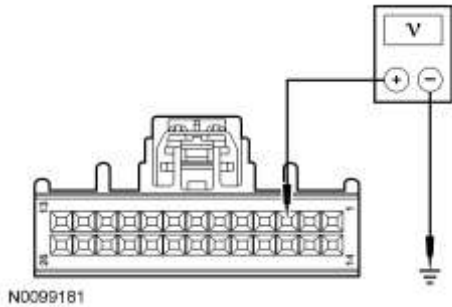

Is any voltage present?

Yes	REPAIR circuit LH111 (BN/WH) for a short to voltage. CLEAR the DTCs. REPEAT the self-test. TEST the system for normal operation.
No	GO to C5 .

C5 CHECK THE HVAC MODULE CONNECTION

- Inspect the HVAC module connectors for:
 - corrosion.
 - pushed-out terminals.
 - damaged terminals.
- Connect and correctly seat all the HVAC module connectors.
- Clear the DTCs.
- Operate the system and verify the concern is still present.

Is the concern still present?

Yes	INSTALL a new HVAC module. REFER to Section 412-01 . TEST the system for normal operation.
No	The system is operating correctly at this time. The concern may have been caused by a loose or corroded connector. CLEAR the DTCs. REPEAT the self-test. TEST the system for normal operation.

Pinpoint Test D: DTCs B1A61:11 and B1A61:15

Refer to Wiring Diagrams Cell [55](#) , Automatic Climate Control System for schematic and connector information.

Normal Operation

Under normal operation, the in-vehicle air temperature sensor receives a ground from the HVAC module. The sensor varies its resistance with the temperature. As the temperature rises, the resistance falls. As the temperature falls the resistance rises. The HVAC module measures this resistance to determine the temperature at the sensor.

- DTC B1A61:11 (Cabin Temperature Sensor: Circuit Short to Ground) — The module senses lower than expected voltage on the sensor feedback circuit, indicating a short to ground.
- DTC B1A61:15 (Cabin Temperature Sensor: Circuit Short to Battery or Open) — The module senses greater than expected voltage on the sensor feedback circuit, indicating a short to voltage or an open circuit or sensor.

This pinpoint test is intended to diagnose the following:

- Wiring, terminals or connectors
- In-vehicle air temperature sensor
- HVAC module

PINPOINT TEST D : DTCS B1A61:11 AND B1A61:15

D1 CHECK THE SENSOR RESISTANCE

- Ignition OFF.
- Disconnect: In-Vehicle Temperature Sensor C233 .
- Measure the resistance between the in-vehicle temperature sensor C233 terminals and compare to the table below.

Ambient Temperature	Resistance
-40°C (-40°F)	869,073-1,061,986 ohms
-15°C (5°F)	196,465-231,213 ohms
0°C (32°F)	89,982-102,514 ohms
15°C (59°F)	44,261-49,503 ohms
25°C (77°F)	28,500-31,500 ohms
35°C (95°F)	18,563-20,751 ohms
60°C (140°F)	6,971-8,001 ohms
85°C (185°F)	2,959-3,474 ohms

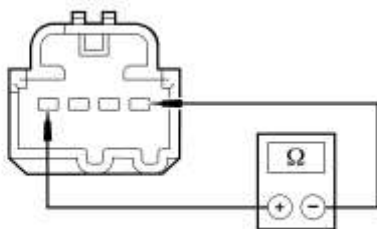

N0099182

Is the resistance within the specified values for the temperatures?

Yes	GO to D2 .
No	INSTALL a new in-vehicle temperature sensor. CLEAR the DTCs. REPEAT the self-test. TEST the system for normal operation.

D2 CHECK THE SENSOR OUTPUT VOLTAGE

- Ignition ON.
- Measure the voltage between in-vehicle temperature sensor [C233](#) Pin 1, circuit VH414 (GN/BU), harness side and [C233](#) Pin 4, circuit RH111 (GY/BU), harness side.

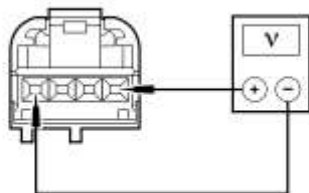

N0099183

Is the voltage between 4.7 and 5.1 volts?

Yes	INSTALL a new in-vehicle sensor. CLEAR the DTCs. REPEAT the self-test. If code returns, GO to D8 .
No	For DTC B1A68:15, GO to D3 . For DTC B1A68:11, GO to D6 .

D3 CHECK CIRCUIT VH414 (GN/BU) FOR A SHORT TO VOLTAGE

- Ignition OFF.
- Disconnect: HVAC Module C294A .
- Disconnect: HVAC Module C294B .
- Ignition ON.
- Measure the voltage between ground and HVAC module [C294B](#) Pin 19, circuit VH414 (GN/BU), harness side.

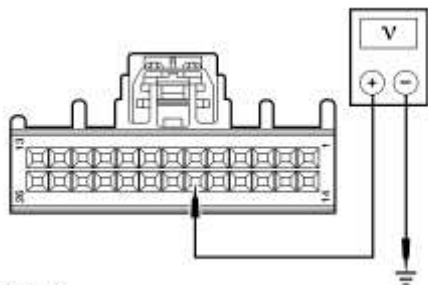

N0099184

Is any voltage present?

Yes	REPAIR circuit VH414 (GN/BU) for a short to voltage. CLEAR the DTCs. REPEAT the self-test. TEST the system for normal operation.
No	GO to D4 .

D4 CHECK CIRCUIT VH414 (GN/BU) FOR AN OPEN

- Ignition OFF.
- Measure the resistance between HVAC module [C294B](#) Pin 19, circuit VH414 (GN/BU), harness side and in-vehicle temperature sensor [C233](#) Pin 1, circuit VH414 (GN/BU), harness side.

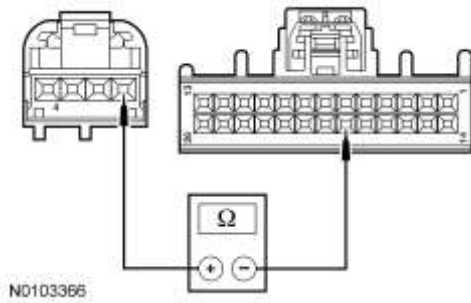

Is the resistance less than 5 ohms?

Yes	GO to D5 .
No	REPAIR circuit VH414 (GN/BU) for an open. CLEAR the DTCs. REPEAT the self-test. TEST the system for normal operation.

D5 CHECK CIRCUIT RH111 (GY/BU) FOR AN OPEN

- Measure the resistance between HVAC module [C294A](#) Pin 4, circuit RH111 (GY/BU), harness side and in-vehicle temperature sensor [C233](#) Pin 4, circuit RH111 (GY/BU), harness side.

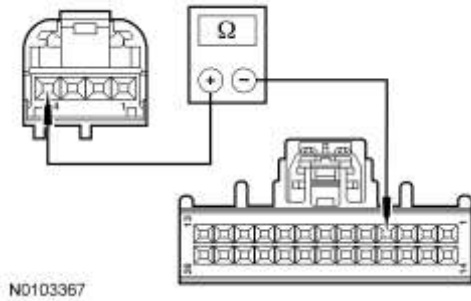

Is the resistance less than 5 ohms?

Yes	GO to D8 .
No	REPAIR circuit RH111 (GY/BU) for an open. CLEAR the DTCs. REPEAT the self-test. TEST the system for normal operation.

D6 CHECK CIRCUIT VH414 (GN/BU) FOR A SHORT TO CIRCUIT RH111 (GY/BU)

- Ignition OFF.
- Disconnect: HVAC Module C294B .
- Measure the resistance between in-vehicle temperature sensor [C233](#) Pin 1, circuit VH414 (GN/BU), harness side and [C233](#) Pin 4, circuit RH111 (GY/BU), harness side.

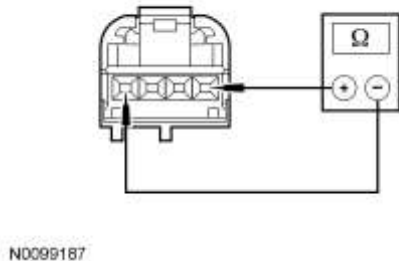

Is the resistance greater than 10,000 ohms?

Yes	GO to D7 .
No	REPAIR circuit VH414 (GN/BU) for a short to circuit RH111 (GY/BU). CLEAR the DTCs. REPEAT the self-test. TEST the system for normal operation.

D7 CHECK CIRCUIT VH414 (GN/BU) FOR A SHORT TO GROUND

- Measure the resistance between HVAC module [C294B](#) Pin 19, circuit VH414 (GN/BU), harness side and ground.

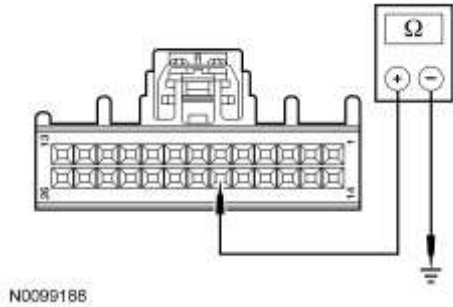

Is the resistance greater than 10,000 ohms?

Yes	GO to D8 .
No	REPAIR circuit VH414 (GN/BU) for a short to ground. CLEAR the DTCs. REPEAT the self-test. TEST the system for normal operation.

D8 CHECK THE HVAC MODULE CONNECTION

- Inspect the HVAC module connectors for:
 - corrosion.
 - pushed-out terminals.
 - damaged terminals.
- Connect and correctly seat all the HVAC module connectors.
- Clear the DTCs.
- Operate the system and verify the concern is still present.

Is the concern still present?

Yes	INSTALL a new HVAC module. REFER to Section 412-01 . TEST the system for normal operation.
No	The system is operating correctly at this time. The concern may have been caused by a loose or corroded connector. CLEAR the DTCs. REPEAT the self-test. TEST the system for normal operation.

Pinpoint Test E: DTCs B1A68:11 and B1A68:15

Refer to Wiring Diagrams Cell [54](#) , Manual Climate Control System for schematic and connector information.

Refer to Wiring Diagrams Cell [55](#) , Automatic Climate Control System for schematic and connector information.

Normal Operation

Under normal operation, the ambient air temperature sensor receives a ground from the HVAC module. The sensor varies its resistance with the temperature. As the temperature rises, the resistance falls. As the temperature falls the resistance rises. The HVAC module measures this resistance to determine the temperature at the sensor.

- DTC B1A68:11 (Ambient Temperature Sensor: Circuit Short to Ground) — The module senses lower than expected voltage on the sensor feedback circuit, indicating a short to ground.
- DTC B1A68:15 (Ambient Temperature Sensor: Circuit Short to Battery or Open) — The module senses greater than expected voltage on the sensor feedback circuit, indicating a short to voltage or an open circuit or sensor.

This pinpoint test is intended to diagnose the following:

- Wiring, terminals or connectors
- Ambient air temperature sensor
- HVAC module

PINPOINT TEST E : DTCS B1A68:11 AND B1A68:15

E1 CHECK THE SENSOR RESISTANCE

- Ignition OFF.
- Disconnect: Ambient Air Temperature Sensor C132 .
- Measure the resistance between the ambient air temperature sensor C132 terminals and compare to the table below.

Ambient Temperature	Resistance
-40°C (-40°F)	832,519-1,017,523 ohms
-15°C (5°F)	199,325-220,307 ohms
0°C (32°F)	91,058-100,644 ohms
15°C (59°F)	44,435-49,113 ohms
25°C (77°F)	28,500-31,500 ohms
35°C (95°F)	18,730-20,701 ohms
60°C (140°F)	7,171-7,925 ohms
85°C (185°F)	3,110-3,438 ohms

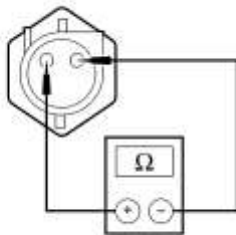

A0013640

Is the resistance within the specified values for the temperatures?

Yes	GO to E2 .
No	INSTALL a new ambient air temperature sensor. CLEAR the DTCs. REPEAT the self-test. TEST the system for normal operation.

E2 CHECK THE SENSOR OUTPUT VOLTAGE

- Ignition ON.

- Measure the voltage between ambient air temperature sensor [C132](#) Pin 1, circuit VH407 (YE/GN), harness side and [C132](#) Pin 2, circuit RH111 (GY/BU), harness side.

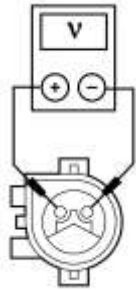

A0002B18

Is the voltage between 4.7 and 5.1 volts?

Yes	INSTALL a new ambient air temperature sensor. CLEAR the DTCs. REPEAT the self-test. If code returns, GO to E8 .
No	For DTC B1A61:15, GO to E3 . For DTC B1A61:11, GO to E6 .

E3 CHECK CIRCUIT VH407 (YE/GN) FOR A SHORT TO VOLTAGE

- Ignition OFF.
- Disconnect: HVAC Module C294A .
- Ignition ON.
- Measure the voltage between HVAC module [C294A](#) Pin 12, circuit VH407 (YE/GN), harness side and ground.

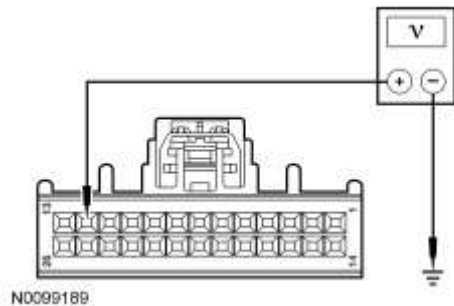

N0099189

Is any voltage present?

Yes	REPAIR circuit VH407 (YE/GN) for a short to ground. CLEAR the DTCs. REPEAT the self-test. TEST the system for normal operation.
No	GO to E4 .

E4 CHECK CIRCUIT VH407 (YE/GN) FOR AN OPEN

- Ignition OFF.
- Measure the resistance between HVAC module [C294A](#) Pin 12, circuit VH407 (YE/GN), harness side and ambient air temperature sensor [C132](#) Pin 1, circuit VH407 (YE/GN), harness side.

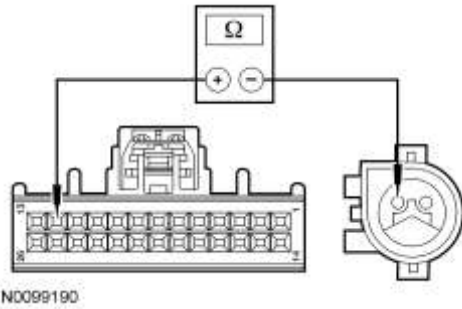

Is the resistance less than 5 ohms?

Yes	GO to E5 .
No	REPAIR circuit VH407 (YE/GN) for an open. CLEAR the DTCs. REPEAT the self-test. TEST the system for normal operation.

E5 CHECK CIRCUIT RH111 (GY/BU) FOR AN OPEN

- Measure the resistance between HVAC module [C294A](#) Pin 4, circuit RH111 (GY/BU), harness side and ambient air temperature sensor [C132](#) Pin 2, circuit RH111 (GY/BU), harness side.

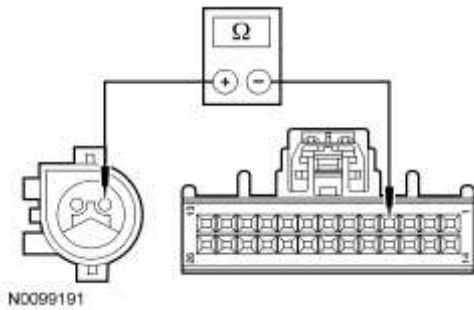

Is the resistance less than 5 ohms?

Yes	GO to E8 .
No	REPAIR circuit RH111 (GY/BU) for an open. CLEAR the DTCs. REPEAT the self-test. TEST the system for normal operation.

E6 CHECK CIRCUIT VH407 (YE/GN) FOR A SHORT TO CIRCUIT RH111 (GY/BU)

- Ignition OFF.
- Disconnect: HVAC Module C294A .
- Measure the resistance between ambient air temperature sensor [C132](#) Pin 1, circuit VH407 (YE/GN), harness side and [C132](#) Pin 2, circuit RH111 (GY/BU), harness side.

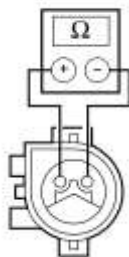

A003B06B

Is the resistance greater than 10,000 ohms?

Yes	GO to E7 .
No	REPAIR circuit VH407 (YE/GN) for a short to circuit RH111 (GY/BU). CLEAR the DTCs. REPEAT the self-test. TEST the system for normal operation.

E7 CHECK CIRCUIT VH407 (YE/GN) FOR A SHORT TO GROUND

- Measure the resistance between HVAC module [C294A](#) Pin 12, circuit VH407 (YE/GN), harness side and ground.

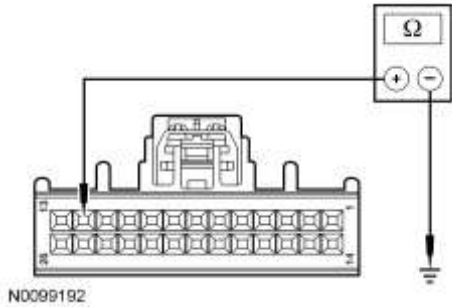

Is the resistance greater than 10,000 ohms?

Yes	GO to E8 .
No	REPAIR circuit VH407 (YE/GN) for a short to ground. CLEAR the DTCs. REPEAT the self-test. TEST the system for normal operation.

E8 CHECK THE HVAC MODULE CONNECTION

- Inspect the HVAC module connectors for:
 - corrosion.
 - pushed-out terminals.
 - damaged terminals.
- Connect and correctly seat all the HVAC module connectors.
- Clear the DTCs.
- Operate the system and verify the concern is still present.

Is the concern still present?

Yes	INSTALL a new HVAC module. REFER to Section 412-01 . TEST the system for normal operation.
No	The system is operating correctly at this time. The concern may have been caused by a loose or corroded connector. CLEAR the DTCs. REPEAT the self-test. TEST the system for normal operation.

Pinpoint Test F: DTCs B1A63:11 and B1A63:15 or DTCs B1A64:11 and B1A64:15

Refer to Wiring Diagrams Cell [55](#) , Automatic Climate Control System for schematic and connector information.

Normal Operation

Under normal operation, the sunload sensor receives a ground from the HVAC module. As the light applied to the sensor changes, the PCM detects the change through the RH and LH feedback circuits.

DTC Description	Fault Trigger Conditions
<ul style="list-style-type: none"> B1A63:11 — Right Solar Sensor: Circuit Short to Ground 	The module senses lower than expected voltage on the RH sensor feedback circuit, indicating a short to ground.
<ul style="list-style-type: none"> B1A63:15 — Right Solar Sensor: Circuit Short to Battery or Open 	The module senses greater than expected voltage on the RH sensor feedback circuit, indicating a short to voltage or an open circuit or sensor.
<ul style="list-style-type: none"> B1A64:11 — Left Solar Sensor: Circuit Short to Ground 	The module senses lower than expected voltage on the LH sensor feedback circuit, indicating a short to ground.
<ul style="list-style-type: none"> B1A64:15 — Left Solar Sensor: Circuit Short to Battery or Open 	The module senses greater than expected voltage on the LH sensor feedback circuit, indicating a short to voltage or an open circuit or sensor.

This pinpoint test is intended to diagnose the following:

- Wiring, terminals or connectors
- Sunload sensor
- HVAC module

PINPOINT TEST F : DTCS B1A63:11 AND B1A63:15 OR DTCS B1A64:11 AND B1A64:15

F1 CHECK THE SUNLOAD SENSOR REFERENCE VOLTAGE

- Ignition OFF.
- Disconnect: Sunload Sensor C2360 .
- Ignition ON.
- Press the AUTO button.
- Measure the voltage between sunload sensor [C2360](#) Pin 4, circuit GD116 (BK/VT), harness side and sunload sensor:
 - For DTC **B1A63**, [C2360](#) Pin 1, circuit VH417 (YE/OG), harness side.
 - For DTC **B1A64**, [C2360](#) Pin 3, circuit VH416 (VT/GY), harness side.

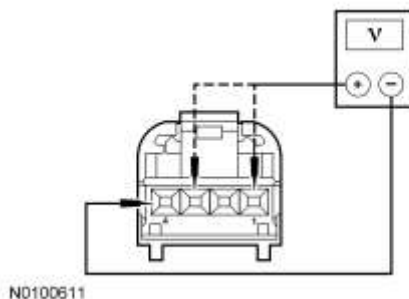

Is the voltage between 4.7 and 5.1 volts?

Yes	INSTALL a new sunload sensor. CLEAR the DTCs. REPEAT the self-test. If the code returns, GO to F6 .
No	If diagnosing DTC B1A63:15 or DTC B1A64:15 , GO to F2 . If diagnosing DTC B1A63:11 or DTC B1A64:11 , GO to F5 .

F2 CHECK CIRCUITS VH416 (VT/GY) AND VH417 (YE/OG) FOR A SHORT TO VOLTAGE

- Ignition OFF.
- Disconnect: HVAC Module C294A .
- Disconnect: HVAC Module C294B .
- Ignition ON.
- Measure the voltage between ground and sunload sensor:
 - For DTC B1A64:11, [C2360](#) Pin 3, circuit VH416 (VT/GY), harness side.
 - For DTC B1A63:11, [C2360](#) Pin 1, circuit VH417 (YE/OG), harness side.

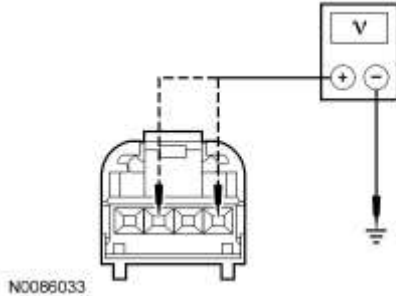

Is any voltage present?

Yes	REPAIR circuit VH416 (VT/GY) or VH417 (YE/OG) for a short to voltage. CLEAR the DTCs. REPEAT the self-test. TEST the system for normal operation.
No	GO to F3 .

F3 CHECK CIRCUIT GD116 (BK/VT) FOR AN OPEN

NOTE: Failure to disconnect the battery will result in false resistance readings.

- Ignition OFF.
- Disconnect the battery. Refer to [Section 414-01](#)
- Measure the resistance between ground and sunload sensor [C2360](#) Pin 4, circuit GD116 (BK/VT), harness side.

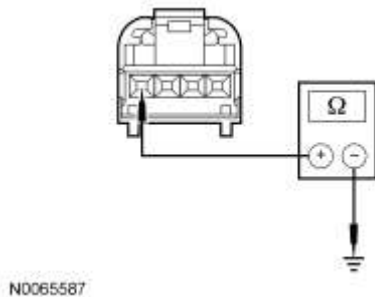

Is the resistance less than 5 ohms?

Yes	GO to F4 .
No	REPAIR circuit GD116 (BK/VT) for an open. CLEAR the DTCs. REPEAT the self-test. TEST the system for normal operation.

F4 CHECK CIRCUIT VH417 (YE/OG) OR CIRCUIT VH416 (VT/GY) FOR AN OPEN

- Measure the resistance between HVAC module [C294B](#) Pin 8, circuit VH416 (VT/GY), harness side and sunload sensor [C2360](#) Pin 3, circuit VH416 (VT/GY), harness side.

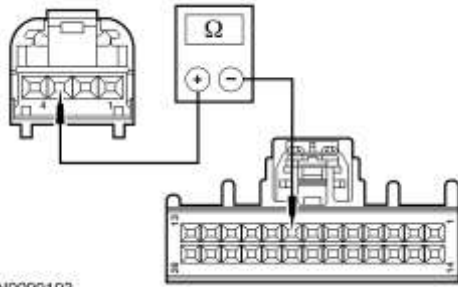

N0099193

- Measure the resistance between HVAC module [C294B](#) Pin 11, circuit VH417 (YE/OG), harness side and sunload sensor [C2360](#) Pin 1, circuit VH417 (YE/OG), harness side.

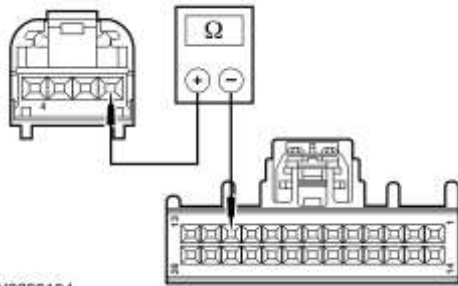

N0099194

Is the resistance less than 5 ohms?

Yes	GO to F6 .
No	REPAIR circuit VH416 (VT/GY) or circuit VH417 (YE/OG) for an open. CLEAR the DTCs. REPEAT the self-test. TEST the system for normal operation.

F5 CHECK CIRCUIT VH417 (YE/OG) OR VH416 (VT/GY) FOR A SHORT TO GROUND

- Ignition OFF.
- Disconnect: HVAC Module C294A .
- Disconnect: HVAC Module C294B .
- Measure the resistance between ground and sunload sensor:
 - For DTC B1A64:11, [C2360](#) Pin 3, circuit VH416 (VT/GY), harness side.
 - For DTC B1A63:11, [C2360](#) Pin 1, circuit VH417 (YE/OG), harness side.

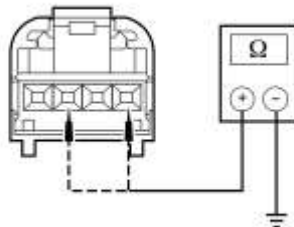

N0041881

Is the resistance greater than 10,000 ohms?

Yes	GO to F6 .
No	REPAIR circuits VH417 (YE/OG) and VH416 (VT/GY) for a short to circuit RH111 (GY/BU). CLEAR the DTCs. REPEAT the self-test. TEST the system for normal operation.

F6 CHECK THE HVAC MODULE CONNECTION

- Inspect the HVAC module connectors for:
 - corrosion.
 - pushed-out terminals.
 - damaged terminals.
- Connect and correctly seat all the HVAC module connectors.
- Clear the DTCs.
- Operate the system and verify the concern is still present.

Is the concern still present?

Yes	INSTALL a new HVAC module. REFER to Section 412-01 . TEST the system for normal operation.
No	The system is operating correctly at this time. The concern may have been caused by a loose or corroded connector. CLEAR the DTCs. REPEAT the self-test. TEST the system for normal operation.

Pinpoint Test G: DTCs B1B71:11 and B1B71:15

Refer to Wiring Diagrams Cell [54](#) , Manual Climate Control System for schematic and connector information.

Refer to Wiring Diagrams Cell [55](#) , Automatic Climate Control System for schematic and connector information.

Normal Operation

Under normal operation, the evaporator discharge air temperature sensor receives a ground from the HVAC module. The sensor varies its resistance with the temperature. As the temperature rises, the resistance falls. As the temperature falls, the resistance rises. The HVAC module measures this resistance to determine the temperature at the sensor.

The evaporator temperature sensor is used for A/C compressor cycling. An accurate evaporator temperature is critical to prevent evaporator icing. The temperature measurement is used by the HVAC module to turn off the A/C compressor before the evaporator temperatures are cold enough to freeze the condensation. This prevents ice blockage of airflow over the evaporator core.

- DTC B1B71:11 (Evaporator Discharge Air Temperature Sensor: Circuit Short to Ground) — The module senses lower than expected voltage on the sensor feedback circuit, indicating a short to ground.
- DTC B1B71:15 (Evaporator Discharge Air Temperature Sensor: Circuit Short to Battery or Open) — The module senses greater than expected voltage on the sensor feedback circuit, indicating a short to voltage or an open circuit or sensor.

This pinpoint test is intended to diagnose the following:

- Wiring, terminals or connectors
- Evaporator discharge air temperature sensor
- HVAC module

PINPOINT TEST G : DTCS B1B71:11 AND B1B71:15

G1 CHECK THE SENSOR RESISTANCE

- Ignition OFF.
- Disconnect: Evaporator Discharge Air Temperature Sensor C296 .
- Measure the resistance between the evaporator discharge air temperature sensor C296 terminals and compare to the table below.

Ambient Temperature	Resistance
-40°C (-40°F)	1,005,00-1,104,000 ohms
-20°C (-4°F)	287,811-307,800 ohms

Ambient Temperature	Resistance
0°C (32°F)	96,890-101,300 ohms
20°C (68°F)	37,080-38,000 ohms
25°C (77°F)	29,700-30,300 ohms
30°C (86°F)	23,840-24,430 ohms
35°C (95°F)	19,260-19,820 ohms
40°C (104°F)	15,660-16,180 ohms
60°C (140°F)	7,239-7,594 ohms
100°C (212°F)	1,943-2,091 ohms

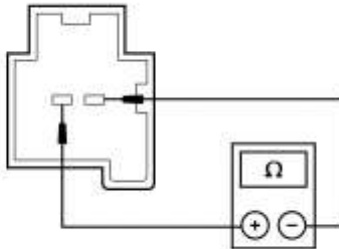

A0004761

Is the resistance within the specified values for the temperatures?

Yes	GO to G2 .
No	INSTALL an evaporator discharge air temperature sensor. CLEAR the DTCs. REPEAT the self-test. TEST the system for normal operation.

G2 CHECK THE SENSOR OUTPUT VOLTAGE

- Ignition ON.
- Press the AUTO button.
- Measure the voltage between evaporator discharge air temperature sensor [C296](#) Pin 2, circuit VH406 (VT/BN), harness side and [C296](#) Pin 1, circuit RH111 (GY/BU), harness side.

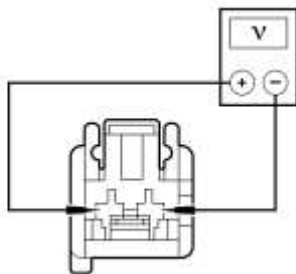

N0100469

Is the voltage between 4.7 and 5.1 volts?

Yes	GO to G8 .
No	For DTC B1B71:15, GO to G3 . For DTC B1B71:11, GO to G6 .

G3 CHECK CIRCUIT VH406 (VT/BN) FOR A SHORT TO VOLTAGE

- Ignition OFF.
- Disconnect: HVAC Module C294A .
- Ignition ON.
- Measure the voltage between ground and HVAC module [C294A](#) Pin 8, circuit VH406 (VT/BN), harness side and ground.

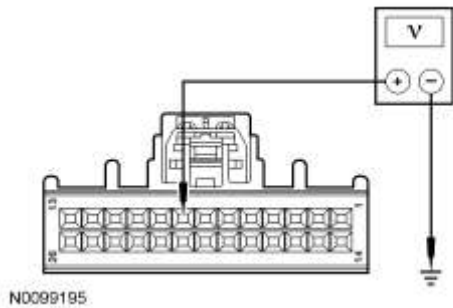

Is any voltage present?

Yes	REPAIR circuit VH406 (VT/BN) for a short to voltage. CLEAR the DTCs. REPEAT the self-test. TEST the system for normal operation.
No	GO to G4 .

G4 CHECK CIRCUIT VH406 (VT/BN) FOR AN OPEN

- Ignition OFF.
- Measure the resistance between HVAC module [C294A](#) Pin 8, circuit VH406 (VT/BN), harness side and evaporator discharge air temperature sensor [C296](#) Pin 2, circuit VH406 (VT/BN), harness side.

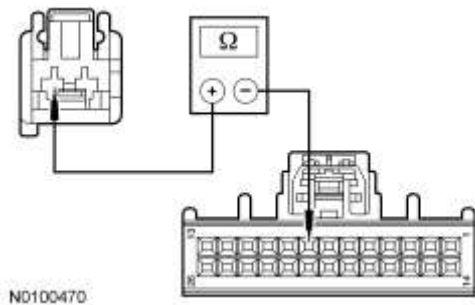

Is the resistance less than 5 ohms?

Yes	GO to G5 .
No	REPAIR circuit VH406 (VT/BN) for an open. CLEAR the DTCs. REPEAT the self-test. TEST the system for normal operation.

G5 CHECK CIRCUIT RH111 (GY/BU) FOR AN OPEN

- Measure the resistance between HVAC module [C294A](#) Pin 4, circuit RH111 (GY/BU), harness side and evaporator discharge air temperature sensor [C296](#) Pin 1, circuit RH111 (GY/BU), harness side.

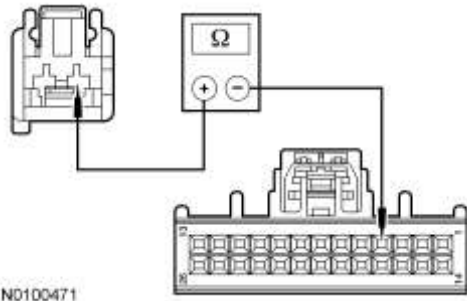

Is the resistance less than 5 ohms?

Yes	GO to G8 .
No	REPAIR circuit RH111 (GY/BU) for an open. CLEAR the DTCs. REPEAT the self-test. TEST the system for normal operation.

G6 CHECK CIRCUIT VH406 (VT/BN) FOR A SHORT TO CIRCUIT RH111 (GY/BU)

- Ignition OFF.
- Disconnect: HVAC Module C294A .
- Measure the resistance between evaporator discharge air temperature sensor [C296](#) Pin 2, circuit VH406 (VT/BN), harness side and [C296](#) Pin 1, circuit RH111 (GY/BU), harness side.

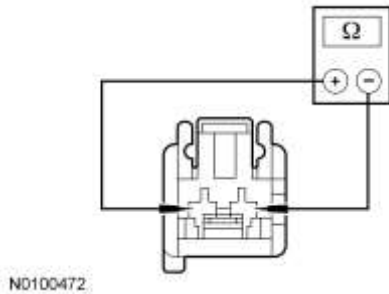

Is the resistance greater than 10,000 ohms?

Yes	GO to G7 .
No	REPAIR circuit VH406 (VT/BN) for a short to circuit RH111 (GY/BU). CLEAR the DTCs. REPEAT the self-test. TEST the system for normal operation.

G7 CHECK CIRCUIT VH406 (VT/BN) FOR A SHORT TO GROUND

- Measure the resistance between HVAC module [C294A](#) Pin 8, circuit VH406 (VT/BN), harness side and ground.

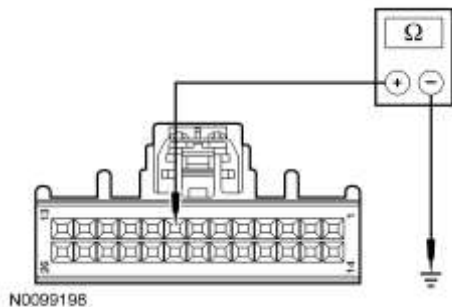

Is the resistance greater than 10,000 ohms?

Yes	GO to G8 .
No	REPAIR circuit VH406 (VT/BN) for a short to ground. CLEAR the DTCs. REPEAT the self-test. TEST the system for normal operation.

G8 CHECK THE HVAC MODULE CONNECTION

- Inspect the HVAC module connectors for:
 - corrosion.
 - pushed-out terminals.
 - damaged terminals.
- Connect and correctly seat all the HVAC module connectors.
- Clear the DTCs.
- Operate the system and verify the concern is still present.

Is the concern still present?

Yes	INSTALL a new HVAC module. REFER to Section 412-01 . TEST the system for normal operation.
No	The system is operating correctly at this time. The concern may have been caused by a loose or corroded connector. CLEAR the DTCs. REPEAT the self-test. TEST the system for normal operation.

Pinpoint Test H: DTCs U3003:16 and U3003:17

Refer to Wiring Diagrams Cell [54](#) , Manual Climate Control System for schematic and connector information.

Refer to Wiring Diagrams Cell [55](#) , Automatic Climate Control System for schematic and connector information.

NOTE: DTC U3003 can be set if the vehicle has been recently jump started, the battery has been recently charged or the battery has been discharged. The battery may become discharged due to excessive load(s) on the charging system from aftermarket accessories or if the battery has been left unattended with the accessories on.

NOTE: Carry out a thorough inspection and verification before proceeding with the pinpoint test. Refer to Inspection and Verification in this section.

Normal Operation

Under normal operation, the HVAC module receives a ground through circuit GD116 (BK/VT). The HVAC module is supplied constant battery voltage through circuit SBP15 (WH/RD).

- DTC U3003:16 (Control Module Input Power "A": Circuit Voltage Below Threshold) — The module senses when battery voltage is less than 9 volts.
- DTC U3003:17 (Control Module Input Power "A": Circuit Voltage Above Threshold) — The module senses when battery voltage is greater than 16 volts.

This pinpoint test is intended to diagnose the following:

- Wiring, terminals or connectors
- HVAC module

PINPOINT TEST H : DTCS U3003:16 AND U3003:17

H1 RETRIEVE ALL CMDTCS IN ALL MODULES

- Ignition ON.
- Enter the following diagnostic mode on the scan tool: Self Test — All [CMDTCS](#) .

Is DTC B1317, B1318 or B1676 present in one or more modules and DTC P0562, P0563, P0620, P0625, P0626 or P065B present in the PCM?

Yes	REFER to Section 414-00 for diagnosis of the battery and charging system.
No	GO to H2 .

H2 CHECK BATTERY CONDITION

- Ignition OFF.
- Refer to [Section 414-01](#) and carry out the Battery — Condition Test

Does the battery pass the condition test?

Yes	If the battery passed the condition test but required a recharge, REFER to Section 414-00 to diagnose the charging system. CLEAR all Continuous Memory Diagnostic Trouble Codes (CMDTCs) . TEST the system for normal operation. If the battery passed the condition test and did not require a recharge, GO to H3 .
No	INSTALL a new battery. CLEAR all <u>CMDTCs</u> . TEST the system for normal operation.

H3 CHECK THE CHARGING SYSTEM VOLTAGE

NOTE: Do not allow the engine rpm to increase above 2,000 rpm while performing this step or the generator may self excite and result in default charging system output voltage. If engine rpm has gone above 2,000 rpm, shut the vehicle OFF and restart the engine before performing this step.

- Start the engine.
- Measure the voltage of the battery:
 - For DTC U3003:16, turn off all accessories and run the engine at 1,500 rpm for a minimum of 2 minutes.
 - For DTC U3003:17, turn on headlights and HVAC fan on high and run engine at 1,500 rpm for a minimum of 2 minutes.

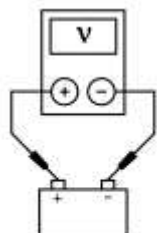

AJ0210-A

Is the battery voltage between 13-15.2 volts?

Yes	For DTC U3003:17, GO to H4 . For DTC U3003:16, INSTALL a new HVAC module. REFER to Section 412-01 . CLEAR all <u>CMDTCs</u> . REPEAT the self-test.
No	REFER to Section 414-00 to diagnose the charging system. CLEAR all <u>CMDTCs</u> . TEST the system for normal operation.

H4 CHECK CIRCUITS SBP15 (WH/RD) FOR AN OPEN

- Ignition OFF.
- Disconnect: HVAC Module C294A .
- Ignition ON.

- With the engine running, measure the voltage between HVAC module [C294A](#) Pin 1, circuit SBP15 (WH/RD), harness side and ground.

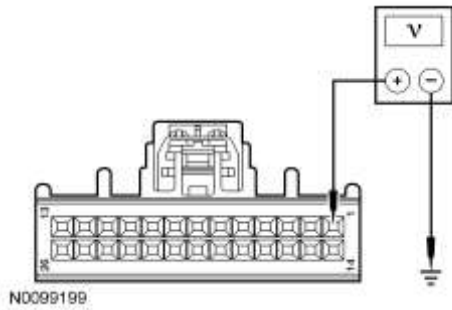

Is the voltage greater than 10 volts?

Yes	GO to H5 .
No	VERIFY Smart Junction Box (SJB) fuse 15 (10A) is OK. If OK, REPAIR circuit SBP15 (WH/RD) for an open. CLEAR all CMDTCs . REPEAT the self-test. If not OK, REFER to the Wiring Diagrams manual to identify the possible causes of the circuit short.

H5 CHECK CIRCUIT GD133 (BK) FOR AN OPEN

- Ignition OFF.
- Measure the resistance between HVAC module [C294A](#) Pin 17, circuit GD116 (BK/VT), harness side and ground.
 - Repeat this measurement while wiggling the harness.

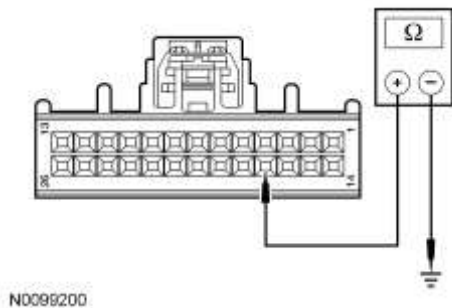

Is the resistance less than 5 ohms?

Yes	GO to H6 .
No	REPAIR circuit GD116 (BK/VT) for an open. TEST the system for normal operation.

H6 CHECK THE HVAC MODULE CONNECTION

- Inspect the HVAC module connectors for:
 - corrosion.
 - pushed-out terminals.
 - damaged terminals.
- Connect and correctly seat all the HVAC module connectors.
- Clear the DTCs.
- Operate the system and verify the concern is still present.

Is the concern still present?

Yes	INSTALL a new HVAC module. REFER to Section 412-01 . TEST the system for normal operation.
------------	--

No	The system is operating correctly at this time. The concern may have been caused by a loose or corroded connector. CLEAR the DTCs. REPEAT the self-test. TEST the system for normal operation.
-----------	--

Pinpoint Test I: Unable To Duplicate The Customers Concern and No DTCs Present

This pinpoint test is intended to diagnose the following:

- Incorrect functioning of the HVAC system

PINPOINT TEST I : UNABLE TO DUPLICATE THE CUSTOMERS CONCERN AND NO DTCS PRESENT

NOTE: Diagnose any HVAC module DTCs before carrying out the following pinpoint test.

NOTE: Some PCM DTCs may inhibit A/C operation. If any PCM DTCs are retrieved, diagnose those first. Refer to PCM DTC Chart.

I1 CHECK THE BLOWER MOTOR OPERATION

- Ignition ON.
- Select PANEL mode.
- Observe blower motor operation and select each blower motor speed.

Does the blower motor operate in all selections and change speed in each?

Yes	GO to I2 .
No	If the blower motor does not operate in any setting, GO to Pinpoint Test Q . If the blower motor does not properly change speeds or shut OFF, GO to Pinpoint Test R .

I2 CHECK AIRFLOW OPERATION

- Select the highest blower motor setting.
- **NOTE:** Refer to Description and Operation in this section for proper airflow descriptions.
While observing the airflow, select each of the airflow positions (PANEL, PANEL/FLOOR, FLOOR, FLOOR/DEFROST, DEFROST).

Is the airflow directed to the proper outlets?

Yes	GO to I3 .
No	GO to Pinpoint Test K .

I3 VERIFY TEMPERATURE CONTROL OPERATION

- Start the vehicle and allow it to reach normal operating temperature.
- With the A/C OFF, select PANEL mode.
- Change the temperature setting from the coldest to the warmest and back to the coldest.

Does the temperature change between very warm to cool?

Yes	GO to I4 .
No	If the temperature does not get very warm, GO to Pinpoint Test L . If the temperature does not change at all, GO to Pinpoint Test P .

I4 VERIFY THE A/C CLUTCH DOES NOT ENGAGE WITH A/C OFF

- With the engine running and the A/C OFF, select PANEL mode.
- Select the coldest temperature setting.

Is the outlet temperature close to ambient temperature?

Yes	GO to I5 .
No	If the temperature is warmer than ambient temperature, GO to Pinpoint Test P and diagnose for inoperative blend door. If the outlet temperature is significantly colder than ambient temperature and the A/C compressor clutch cycles normally, GO to Pinpoint Test O . If the outlet temperature is significantly colder than ambient temperature and the A/C compressor clutch does not cycle, GO to Pinpoint Test N .

I5 VERIFY A/C CLUTCH ENGAGEMENT IN THE A/C MODE

- Make sure the ambient air temperature is above 2°C (35°F).
- With the engine running, select PANEL mode.
- Press the A/C button (indicator ON).

Does the A/C clutch engage when the PANEL and A/C button (indicator ON) is pressed?

Yes	GO to I6 .
No	GO to Pinpoint Test M .

I6 CHECK THE RECIRC OPERATION

- With the engine running, press the RECIRC button (indicator OFF).
- Select PANEL mode.
- Select the highest blower motor setting.
- Observe airflow noise.
- Press the RECIRC button (indicator ON).

Does the airflow noise increase when the RECIRC mode is selected (indicator ON)?

Yes	For Electronic Manual Temperature Control (EMTC) equipped vehicles, the system is operating normally. For Dual Automatic Temperature Control (DATC) equipped vehicles, GO to I7 .
No	GO to Pinpoint Test J .

I7 CHECK IN-VEHICLE TEMPERATURE SENSOR FAN OPERATION

- Make sure the ambient air temperature is above 2°C (35°F).
- With the engine running, select PANEL mode.
- Press the A/C button (indicator ON).
- Press the RECIRC button (indicator ON).
- Place a piece of tissue within 25 mm (1 in) of the in-vehicle temperature sensor opening.

Is the tissue drawn to the sensor opening?

Yes	The system is operating normally.
No	GO to Pinpoint Test S .

Pinpoint Test J: The Air Inlet Door is Inoperative

Refer to Wiring Diagrams Cell [54](#) , Manual Climate Control System for schematic and connector information.

Refer to Wiring Diagrams Cell [55](#) , Automatic Climate Control System for schematic and connector information.

Normal Operation

Under normal operation, to rotate the air inlet mode door actuator, the HVAC module supplies voltage and ground to the air inlet mode door actuator through the actuator motor circuits. To reverse the air inlet mode door actuator rotation, the HVAC module reverses the voltage and ground circuits.

- DTC B1083:00 (Recirculation Damper Motor: No Sub Type Information) — The module senses no voltage on the actuator motor ground circuit when the motor is not commanded ON, indicating an open circuit or internal electrical failure.
- DTC B1083:11 (Recirculation Damper Motor: Circuit Short to Ground) — The module senses lower than expected voltage on an actuator motor circuit when voltage is applied to drive the motor, indicating a short to ground.
- DTC B1083:12 (Recirculation Damper Motor: Circuit Short to Battery) — The module senses greater than expected voltage on the actuator motor circuit when ground is applied to drive the motor, indicating a short to voltage.

This pinpoint test is intended to diagnose the following:

- Wiring, terminals or connectors
- Air inlet mode door actuator
- HVAC module
- Stuck or bound linkage or door

PINPOINT TEST J : THE AIR INLET DOOR IS INOPERATIVE

J1 CHECK THE HVAC MODULE FOR DTCS

- Ignition ON.
- Check the HVAC module for DTCS.

Are any DTCS present?

Yes	For DTC B1083:00, GO to J4 . For DTC B1083:11, GO to J2 . For DTC B1083:12, GO to J3 .
No	INSPECT for broken/binding linkage or door. REPAIR as necessary. If no condition is found, GO to J6 .

J2 CHECK CIRCUITS CH207 (BU/GY) AND CH208 (GN/OG) FOR A SHORT TO GROUND

- Ignition OFF.
- Disconnect: HVAC Module C294A .
- Disconnect: HVAC Module C294B .
- Measure the resistance between ground and:
 - HVAC module [C294A](#) Pin 24, circuit CH208 (GN/OG), harness side.
 - HVAC module [C294A](#) Pin 25, circuit CH207 (BU/GY), harness side.

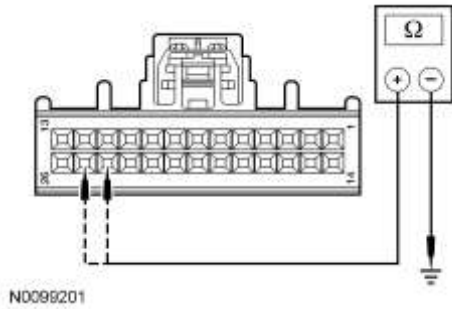

Is the resistance greater than 10,000 ohms?

Yes	GO to J5 .
No	REPAIR circuit CH207 (BU/GY) or CH208 (GN/OG) for a short to ground. CLEAR the DTCs. REPEAT the self-test. TEST the system for normal operation.

J3 CHECK CIRCUITS CH207 (BU/GY) AND CH208 (GN/OG) FOR A SHORT TO VOLTAGE

- Ignition OFF.
- Disconnect: HVAC Module C294A .
- Disconnect: HVAC Module C294B .
- Ignition ON.
- Measure the voltage between ground and:
 - HVAC module [C294A](#) Pin 24, circuit CH208 (GN/OG), harness side.
 - HVAC module [C294A](#) Pin 25, circuit CH207 (BU/GY), harness side.

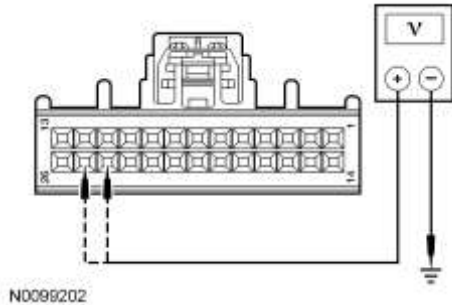

Is any voltage present?

Yes	REPAIR circuit CH207 (BU/GY) or CH208 (GN/OG) for a short to voltage. CLEAR the DTCs. REPEAT the self-test. TEST the system for normal operation.
No	GO to J5 .

J4 CHECK THE ACTUATOR MOTOR DRIVE CIRCUITS FOR AN OPEN

- Ignition OFF.
- Disconnect: HVAC Module C294A .
- Disconnect: HVAC Module C294B .
- Disconnect: Air Inlet Mode Door Actuator C2325 .
- Measure the resistance between HVAC module [C294A](#) Pin 25, circuit CH207 (BU/GY), harness side and air inlet mode door actuator [C2325](#) Pin 1, circuit CH207 (BU/GY), harness side.

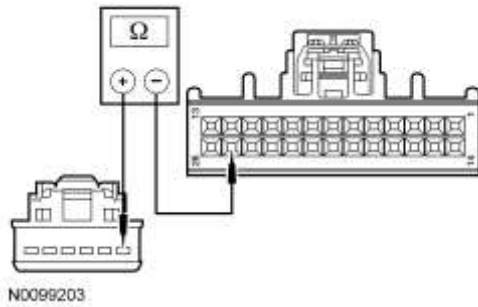

- Measure the resistance between HVAC module [C294A](#) Pin 24, circuit CH208 (GN/OG), harness side and air inlet mode door actuator [C2325](#) Pin 6, circuit CH208 (GN/OG), harness side.

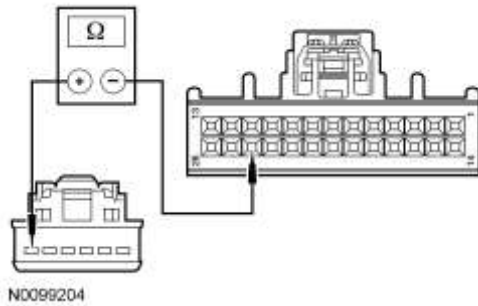

Are the resistances less than 5 ohms?

Yes	GO to J6 .
No	REPAIR the circuit(s) for an open. TEST the system for normal operation.

J5 CHECK CIRCUIT CH207 (BU/GY) FOR A SHORT TO CIRCUIT CH208 (GN/OG)

- Ignition OFF.
- Measure the resistance between HVAC module [C294A](#) Pin 25, circuit CH207 (BU/GY), harness side and HVAC module [C294A](#) Pin 24, circuit CH208 (GN/OG), harness side.

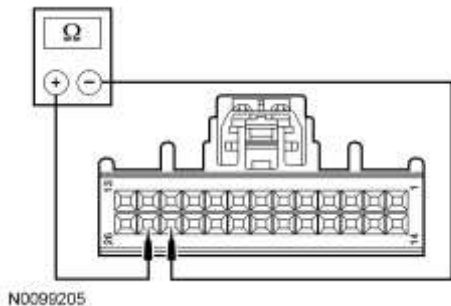

Is the resistance greater than 10,000 ohms?

Yes	GO to J6 .
No	REPAIR circuit CH208 (GN/OG) for a short to circuit CH207 (BU/GY). CLEAR the DTCs. REPEAT the self-test. TEST the system for normal operation.

J6 CHECK THE ACTUATOR CONNECTION

- Disconnect the actuator connector.
- Check for:
 - corrosion.

- pushed-out terminals.
- damaged terminals.
- Connect and correctly seat the actuator connector.
- Clear the DTCs.
- Operate the system and verify the concern is still present.

Is the concern still present?

Yes	CARRY OUT the Air Inlet Mode Door Actuator component test in this section. If the actuator tests OK, GO to J7 .
No	The system is operating correctly at this time. The concern may have been caused by a loose or corroded connector. CLEAR the DTCs. TEST the system for normal operation.

J7 CHECK THE HVAC MODULE CONNECTION

- Inspect the HVAC module connectors for:
 - corrosion.
 - pushed-out terminals.
 - damaged terminals.
- Connect and correctly seat all the HVAC module connectors.
- Clear the DTCs.
- Operate the system and verify the concern is still present.

Is the concern still present?

Yes	INSTALL a new HVAC module. REFER to Section 412-01 . TEST the system for normal operation.
No	The system is operating correctly at this time. The concern may have been caused by a loose or corroded connector. CLEAR the DTCs. REPEAT the self-test. TEST the system for normal operation.

Pinpoint Test K: Incorrect/Erratic Direction of Airflow From Outlets

Refer to Wiring Diagrams Cell [54](#) , Manual Climate Control System for schematic and connector information.

Refer to Wiring Diagrams Cell [55](#) , Automatic Climate Control System for schematic and connector information.

Normal Operation

Under normal operation, to rotate the panel/defrost mode door actuator, the HVAC module supplies voltage or ground to the defrost/panel mode door actuator motor through circuits. To reverse the panel/defrost mode door actuator rotation, the HVAC module reverses the voltage and ground circuits.

The panel/defrost mode door actuator feedback resistor is supplied a 5-volt reference voltage and ground from the HVAC module. The HVAC module measures the resistance on the panel/defrost mode door actuator feedback circuit to determine the panel/defrost mode door actuator position by the position of the actuator feedback resistor wiper arm.

To rotate the floor mode door actuator, the HVAC module supplies voltage or ground to the floor mode door actuator motor through circuits. To reverse the floor mode door actuator rotation, the HVAC module reverses the voltage and ground circuits. The floor mode door actuator is not equipped with a feedback resistor.

During an actuator calibration cycle, the HVAC module drives the panel/defrost mode door until the door reaches both internal stops in the HVAC case. If the panel/defrost mode door is temporarily obstructed or binding during a calibration cycle, the HVAC module may interpret this as the actual end of travel for the door. When this condition occurs and the HVAC module commands the actuator to its end of travel, the airflow may not be from the expected outlets.

DTC Description	Fault Trigger Conditions
<ul style="list-style-type: none"> • B1086:00 — Air Distribution Damper Motor: No Sub Type Information 	The module senses no changes in the feedback circuit when motor movement is commanded and no motor DTCs are present, indicating an open circuit or mechanical failure.
<ul style="list-style-type: none"> • B1086:11 — Air Distribution Damper Motor: Circuit Short to Ground 	The module senses lower than expected voltage on an actuator motor circuit when voltage is applied to drive the motor, indicating a short to ground.
<ul style="list-style-type: none"> • B1086:12 — Air Distribution Damper Motor: Circuit Short to Battery 	The module senses greater than expected voltage on the actuator motor circuit when ground is applied to drive the motor, indicating a short to voltage.
<ul style="list-style-type: none"> • B11E7:11 — Air Distribution Damper Position Sensor: Circuit Short to Ground 	The module senses lower than expected voltage on the actuator feedback circuit, indicating a short to ground.
<ul style="list-style-type: none"> • B11E7:15 — Air Distribution Damper Position Sensor: Circuit Short to Battery or Open 	The module senses greater than expected voltage on the actuator feedback circuit, indicating an open circuit or a short to voltage.
<ul style="list-style-type: none"> • B125B:00 — Air Distribution Damper "B" Motor: No Sub Type Information 	The module senses no voltage on the actuator motor ground circuit when the motor is not commanded ON, indicating an open circuit or internal electrical failure.
<ul style="list-style-type: none"> • B125B:11 — Air Distribution Damper "B" Motor: Circuit Short to Ground 	The module senses lower than expected voltage on an actuator motor circuit when voltage is applied to drive the motor, indicating a short to ground.
<ul style="list-style-type: none"> • B125B:12 — Air Distribution Damper "B" Motor: Circuit Short to Battery 	The module senses greater than expected voltage on the actuator motor circuit when ground is applied to drive the motor, indicating a short to voltage.

This pinpoint test is intended to diagnose the following:

- Wiring, terminals or connectors
- Panel/defrost mode door actuator
- Floor mode door actuator
- HVAC module
- Stuck or bound linkage or door

PINPOINT TEST K : INCORRECT/ERRATIC DIRECTION OF AIRFLOW FROM OUTLETS

K1 CHECK THE HVAC MODULE FOR DTCS	
<ul style="list-style-type: none"> • Ignition ON. • Check the HVAC module for DTCs. 	
Are any DTCs present?	
Yes	<p>For DTC B1086:00, INSPECT for binding/damaged linkage or door. REPAIR as necessary. If no condition is found, GO to K4.</p> <p>For DTC B125B:00, INSPECT for binding/damaged linkage or door. REPAIR as necessary. If no condition is found, GO to K13.</p>

For DTC B1086:11 or DTC B125B:11, GO to [K2](#).
 For DTC B1086:12 or DTC B125B:12, GO to [K3](#).
 For DTC B11E7:11, GO to [K6](#).
 For DTC B11E7:15, GO to [K8](#).

No INSPECT for broken linkage or door. REPAIR as necessary. If no condition is found, GO to [K14](#).

K2 CHECK THE ACTUATOR MOTOR DRIVE CIRCUITS FOR A SHORT TO GROUND

- Ignition OFF.
- Disconnect: HVAC Module C294A .
- Disconnect: HVAC Module C294B .
- Disconnect: **For DTC B1086:11**, Panel/Defrost Mode Door Actuator C232 .
- Disconnect: **For DTC B125B:11**, Floor Mode Door Actuator C234 .

• For DTC B1086:11

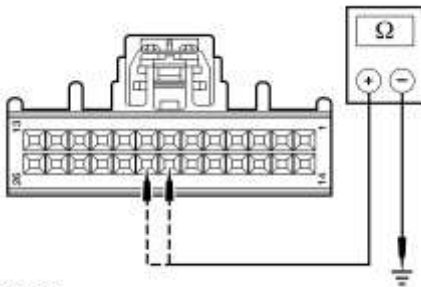

N0099205

NOTE: For DTC B1086:11.

Measure the resistance between ground and:

- HVAC module [C294A](#) Pin 20, circuit CH228 (YE/GY), harness side.
- HVAC module [C294A](#) Pin 21, circuit CH229 (WH/BU), harness side.

• For DTC B125B:11

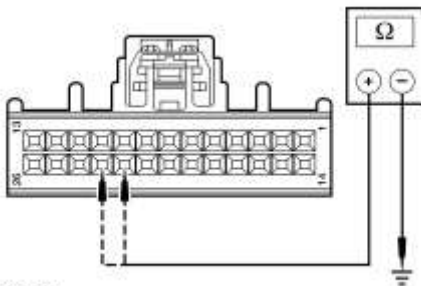

N0099207

NOTE: For DTC B125B:11.

Measure the resistance between ground and:

- HVAC module [C294A](#) Pin 22, circuit CH202 (BU/GN), harness side.
- HVAC module [C294A](#) Pin 23, circuit CH203 (GN/BN), harness side.

Are the resistances greater than 10,000 ohms?

Yes	GO to K5 .
No	REPAIR the circuit CH228 (YE/GY) or CH229 (WH/BU) for a short to ground. TEST the system for normal operation.

K3 CHECK THE ACTUATOR MOTOR DRIVE CIRCUITS FOR A SHORT TO VOLTAGE

- Ignition OFF.
- Disconnect: HVAC Module C294A .
- Disconnect: HVAC Module C294B .
- Disconnect: **For DTC B1086:12**, Panel/Defrost Mode Door Actuator C232 .

- Disconnect: **For DTC B125B:12**, Floor Mode Door Actuator C234 .
- Ignition ON.

- **For DTC B1086:12**

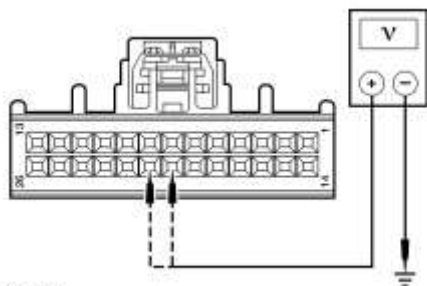

N0099208

NOTE: For DTC B1086:12.

Measure the voltage between ground and:

- HVAC module [C294A](#) Pin 20, circuit CH228 (YE/GY), harness side.
- HVAC module [C294A](#) Pin 21, circuit CH229 (WH/BU), harness side.

- **For DTC B125B:12**

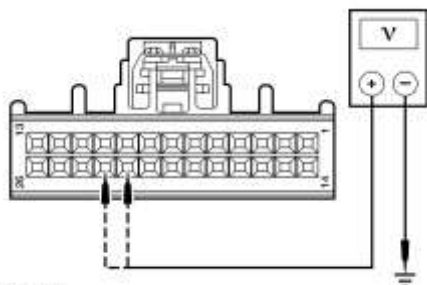

N0099209

NOTE: For DTC B125B:12.

Measure the voltage between ground and:

- HVAC module [C294A](#) Pin 22, circuit CH202 (BU/GN), harness side.
- HVAC module [C294A](#) Pin 23, circuit CH203 (GN/BN), harness side.

Is any voltage present?

Yes	REPAIR the circuit CH228 (YE/GY) or CH229 (WH/BU) for a short to voltage. TEST the system for normal operation.
No	GO to K5 .

K4 CHECK THE ACTUATOR MOTOR DRIVE CIRCUITS FOR AN OPEN

- Ignition OFF.
- Disconnect: HVAC Module C294A .
- Disconnect: HVAC Module C294B .
- Disconnect: Panel/Defrost Mode Door Actuator C232 .
- Measure the resistance between panel/defrost door actuator [C232](#) Pin 6, circuit CH228 (YE/GY), harness side and HVAC module [C294A](#) Pin 20, circuit CH228 (YE/GY), harness side.

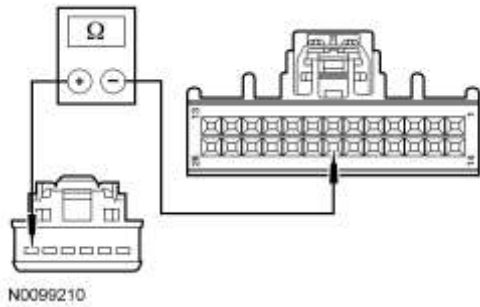

- Measure the resistance between panel/defrost door actuator [C232](#) Pin 1, circuit CH229 (WH/BU), harness side and HVAC module [C294A](#) Pin 21, circuit CH229 (WH/BU), harness side.

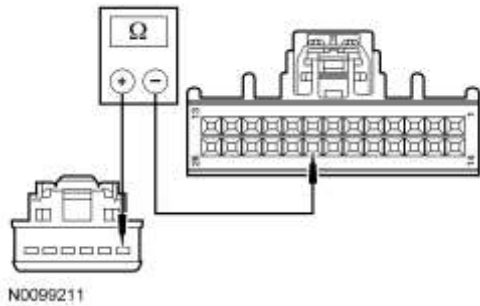

Are the resistances less than 5 ohms?

Yes	GO to K14 .
No	REPAIR the circuit CH228 (YE/GY) or CH229 (WH/BU) for an open. TEST the system for normal operation.

K5 CHECK THE ACTUATOR MOTOR DRIVE CIRCUITS FOR A SHORT TOGETHER

- Ignition OFF.
- For DTC B1086:11 and 12

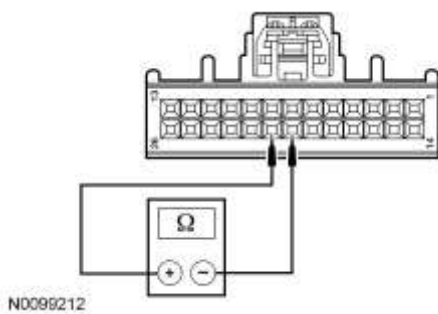

NOTE: For DTC B1086:11 and 12.

Measure the resistance between HVAC module [C294A](#) Pin 20, circuit CH228 (YE/GY), harness side and HVAC module [C294A](#) Pin 21, circuit CH229 (WH/BU), harness side.

- For DTC B125B:11 and 12

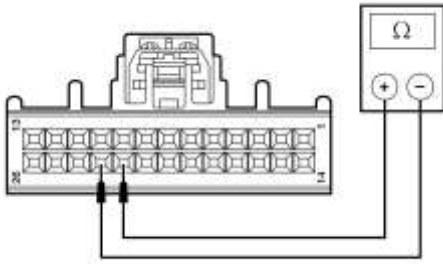

N0112779

NOTE: For DTC B125B:11 and 12.

Measure the resistance between HVAC module [C294A](#) Pin 22, circuit CH202 (BU/GN), harness side and HVAC module [C294A](#) Pin 23, circuit CH203 (GN/BN), harness side.

Is the resistance greater than 10,000 ohms?

Yes	GO to K14 .
No	REPAIR circuits CH228 (YE/GY) and CH229 (WH/BU) for a short together. TEST the system for normal operation.

K6 CHECK CIRCUIT VH436 (YE/VT) FOR A SHORT TO GROUND

- Ignition OFF.
- Disconnect: HVAC Module C294A .
- Disconnect: HVAC Module C294B .
- Measure the resistance between ground and HVAC module [C294A](#) Pin 6, circuit VH436 (YE/VT), harness side.

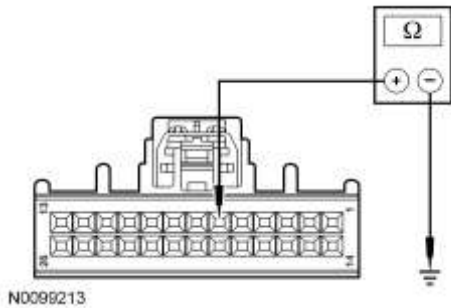

N0099213

Are the resistances greater than 10,000 ohms?

Yes	GO to K7 .
No	REPAIR circuit VH436 (YE/VT) for a short to ground. TEST the system for normal operation.

K7 CHECK CIRCUIT RH111 (GY/BU) FOR A SHORT TO CIRCUIT VH436 (YE/VT)

- Disconnect: Panel/Defrost Mode Door Actuator C232 .
- Measure the resistance between HVAC module [C294A](#) Pin 4, circuit RH111 (GY/BU), harness side and HVAC module [C294A](#) Pin 6, circuit VH436 (YE/VT), harness side.

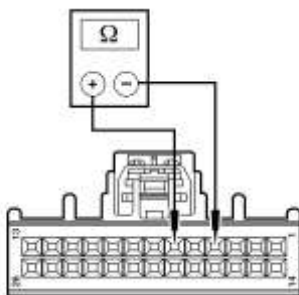

N0099214

Is the resistance greater than 10,000 ohms?

Yes	GO to K14 .
No	REPAIR circuits RH111 (GY/BU) and VH436 (YE/VT) for a short together. TEST the system for normal operation.

K8 CHECK CIRCUIT VH436 (YE/VT) FOR A SHORT TO VOLTAGE

- Ignition OFF.
- Disconnect: HVAC Module C294A .
- Disconnect: HVAC Module C294B .
- Ignition ON.
- Measure the voltage between ground and HVAC module [C294A](#) Pin 6, circuit VH436 (YE/VT), harness side.

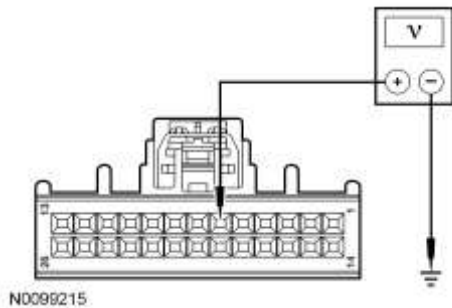

Is any voltage present?

Yes	REPAIR circuit VH436 (YE/VT) for a short to voltage. TEST the system for normal operation.
No	GO to K9 .

K9 CHECK CIRCUIT LH111 (BN/WH) FOR A SHORT TO CIRCUIT VH436 (YE/VT)

- Ignition OFF.
- Disconnect: Panel/Defrost Mode Door Actuator C232 .
- Measure the resistance between HVAC module [C294A](#) Pin 3, circuit LH111 (BN/WH), harness side and HVAC module [C294A](#) Pin 6, circuit VH436 (YE/VT), harness side.

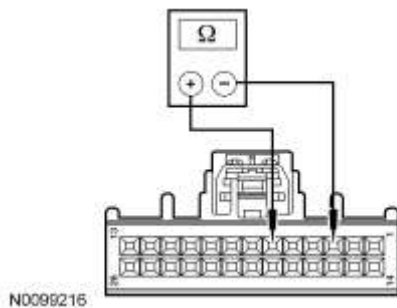

Is the resistance greater than 10,000 ohms?

Yes	GO to K10 .
No	REPAIR circuits LH111 (BN/WH) and VH436 (YE/VT) for a short together. TEST the system for normal operation.

K10 CHECK CIRCUIT VH436 (YE/VT) FOR AN OPEN

- Measure the resistance between HVAC module [C294A](#) Pin 6, circuit VH436 (YE/VT), harness side and panel/defrost mode door actuator [C232](#) Pin 4, circuit VH436 (YE/VT), harness side.

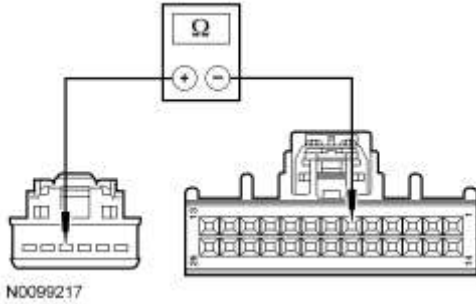

Is the resistance less than 5 ohms?

Yes	GO to K11 .
No	REPAIR circuit VH436 (YE/VT) for an open. TEST the system for normal operation.

K11 CHECK THE ACTUATOR RETURN CIRCUIT RH111 (GY/BU) FOR AN OPEN

- Measure the resistance between HVAC module [C294A](#) Pin 4, circuit RH111 (GY/BU), harness side and panel/defrost mode door actuator [C232](#) Pin 2, circuit RH111 (GY/BU), harness side.

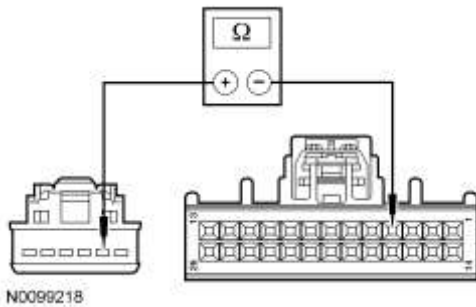

Is the resistance less than 5 ohms?

Yes	GO to K12 .
No	REPAIR circuit RH111 (GY/BU) for an open. TEST the system for normal operation.

K12 CHECK CIRCUIT LH111 (BN/WH) FOR AN OPEN

- Measure the resistance between HVAC module [C294A](#) Pin 3, circuit LH111 (BN/WH), harness side and panel/defrost mode door actuator [C232](#) Pin 3, circuit LH111 (BN/WH), harness side.

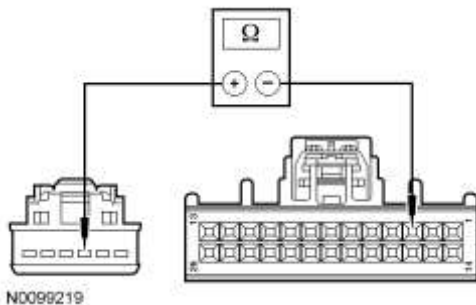

Is the resistance less than 5 ohms?

Yes	GO to K14 .
No	REPAIR circuit LH111 (BN/WH) for an open. TEST the system for normal operation.

K13 CHECK THE ACTUATOR MOTOR DRIVE CIRCUITS FOR AN OPEN

- Ignition OFF.
- Disconnect: HVAC Module C294A .
- Disconnect: HVAC Module C294B .
- Disconnect: Floor Mode Door Actuator C234 .
- Measure the resistance between floor mode door actuator [C234](#) Pin 5, circuit CH202 (BU/GN), harness side and HVAC module [C294A](#) Pin 22, circuit CH202 (BU/GN), harness side.

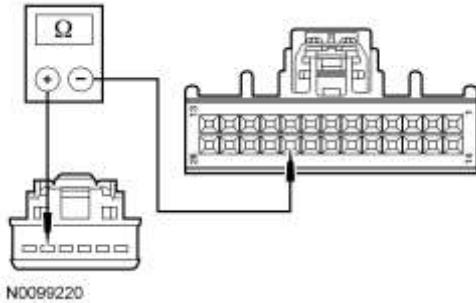

- Measure the resistance between floor mode door actuator [C234](#) Pin 6, circuit CH203 (GN/BN), harness side and HVAC module [C294A](#) Pin 23, circuit CH203 (GN/BN), harness side.

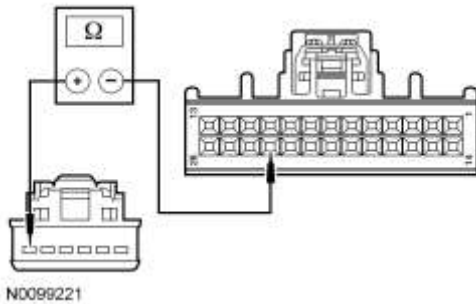

Are the resistances less than 5 ohms?

Yes	GO to K14 .
No	REPAIR the circuit CH202 (BU/GN) or CH203 (GN/BN) for an open. TEST the system for normal operation.

K14 CHECK THE ACTUATOR CONNECTION

- Inspect the connector for:
 - corrosion.
 - pushed-out terminals.
 - damaged terminals.
- Connect and correctly seat the actuator connector.
- Clear the DTCs.
- Operate the system and verify the concern is still present.

Is the concern still present?

Yes	CARRY OUT the Panel/Defrost Mode Door Actuator or Floor Mode Door Actuator component test in this section. If the actuator tests OK, GO to K15 .
No	The system is operating correctly at this time. The concern may have been caused by a loose or corroded connector. CLEAR the DTCs. TEST the system for normal operation.

K15 MODULE ACTUATOR POSITION CALIBRATION

NOTE: The purpose of the module actuator position calibration is to allow the HVAC module to reinitialize and calibrate the actuator stop points. To carry out the calibration, follow the steps below.

- Ignition OFF.
 - Inspect the HVAC module connectors for:
 - corrosion.
 - pushed-out terminals.
 - damaged terminals.
 - Connect and correctly seat all the HVAC module connectors.
 - Ignition ON.
 - Clear the DTCs.
 - Select any position except OFF.
 - **NOTE:** The HVAC module will now initialize and calibrate the actuators. Calibration of the actuators will take approximately 30 seconds.
- Operate the system and verify the concern is still present.

Is the concern still present?

Yes	INSTALL a new HVAC module. REFER to Section 412-01 . TEST the system for normal operation.
No	The system is now operating correctly at this time. The concern may have been caused by a foreign object in the HVAC case or temporary binding that restricted actuator door travel. CHECK any actuator external linkage. If condition recurs, INSPECT actuator linkage and door for binding and CHECK HVAC case for foreign objects.

Pinpoint Test L: Insufficient, Erratic or No Heat

Normal Operation

Under normal operation, warm coolant flows from the engine through the heater core and back to the engine.

This pinpoint test is intended to diagnose the following:

- Plugged heater core
- Coolant level
- Temperature blend door
- Stuck or bound temperature blend door or linkage

PINPOINT TEST L : INSUFFICIENT, ERRATIC OR NO HEAT

L1 CHECK FOR CORRECT ENGINE COOLANT LEVEL

- Ignition OFF.
- Check the engine coolant level when hot and cold.

Is the engine coolant at the correct level (hot/cold) as indicated on the engine coolant recovery reservoir?

Yes	GO to L3 .
No	GO to L2 .

L2 CHECK THE ENGINE COOLING SYSTEM FOR LEAKS

- Pressure test the cooling system for leaks. Refer to [Section 303-03A](#) or [Section 303-03B](#).

Does the engine cooling system leak?

Yes	REPAIR the engine coolant leak. TEST the system for normal operation.
No	FILL and BLEED the cooling system. REFER to Section 303-03A or Section 303-03B . After filling and bleeding the cooling system, GO to L3 .

L3 CHECK FOR COOLANT FLOW TO THE HEATER CORE

- Run the engine until it reaches normal operation temperature. Select the FLOOR position on the control assembly. Set the temperature control to full warm and the blower to the lowest setting.
- Using a suitable temperature measuring device, check the heater core inlet hose to see if it is hot.

Is the heater core inlet hose hot?

Yes	GO to L4 .
No	REFER to Section 303-03A or Section 303-03B to check cooling system function.

L4 CHECK FOR A PLUGGED OR RESTRICTED HEATER CORE

- Using a suitable temperature measuring device, measure the heater core outlet hose temperature.

Is the heater core outlet hose temperature similar to the inlet hose temperature (within approximately 6-17°C [10-30°F])?

Yes	GO to Pinpoint Test P and diagnose for a temperature blend door actuator.
No	INSTALL a new heater core. TEST the system for normal operation.

Pinpoint Test M: The Air Conditioning (A/C) is Inoperative

Refer to Wiring Diagrams Cell [54](#) , Manual Climate Control System for schematic and connector information.

Refer to Wiring Diagrams Cell [55](#) , Automatic Climate Control System for schematic and connector information.

Normal Operation

Under normal operation, when the A/C button is pressed, a message is sent from the Front Controls Interface Module (FCIM) over the Medium Speed Controller Area Network (MS-CAN) bus to the HVAC module. The HVAC module then sends an A/C request message over the MS-CAN bus to the Instrument Cluster (IC) , then from the IC through the High Speed Controller Area Network (HS-CAN) bus to the PCM.

For **all vehicles equipped with navigation**, when MAX A/C is selected on the touch screen, the Audio Front Control Module (ACM) sends a message over the MS-CAN bus to the HVAC module that MAX A/C has been selected.

Voltage is provided to the A/C clutch relay coil and switch contacts. When A/C is requested and A/C line pressures allow, a ground is provided to the A/C clutch relay coil from the PCM, energizing the A/C clutch relay. When the PCM energizes the relay, voltage is supplied to the A/C clutch from the relay. Ground is supplied for the A/C clutch.

The evaporator temperature sensor is used for A/C compressor cycling. An accurate evaporator temperature is critical for compressor engagement. The temperature measurement is used by the PCM to turn off the A/C compressor before the evaporator temperatures are cold enough to freeze the condensation.

When an A/C request is received by the PCM, the A/C compressor clutch will only be engaged through the A/C clutch relay if all of the following conditions are met:

- The PCM does not detect excessively high or low refrigerant pressure from the A/C pressure transducer.
- The PCM does not detect excessively high engine coolant temperature.
- The PCM does not detect an ambient air temperature below -1°C (30°F).
- The PCM has not detected a Wide Open Throttle (WOT) condition.
- The HVAC module does not detect an evaporator discharge air temperature below 7.5°C (45.5°F).

This pinpoint test is intended to diagnose the following:

- Fuse(s)
- Wiring, terminals or connectors
- PCM
- HVAC module
- FCIM
- ACM
- Evaporator discharge air temperature sensor
- A/C pressure transducer
- A/C compressor clutch field coil
- A/C control relay
- A/C compressor clutch air gap

PINPOINT TEST M : THE AIR CONDITIONING (A/C) IS INOPERATIVE

NOTE: Before carrying out the following test, diagnose any HVAC, PCM, ACM, FCIM or IC DTCs.

NOTE: Before carrying out the following test, check that the A/C system pressure is above 290 kPa (42 psi). If the pressure is below 290 kPa (42 psi), refer to [Fluorescent Dye Leak Detection](#) in this section.

M1 CHECK THE A/C PRESSURE SENSOR (ACP_PRESS) PCM PID

- Ignition ON.
- Enter the following diagnostic mode on the scan tool: ACP_PRESS PCM PID .
- With the manifold gauge set connected, compare the pressure readings of the manifold gauge set and the ACP_PRESS PCM PID.

Are the pressure values of the manifold gauge set and the ACP_PRESS PCM PID similar?

Yes	GO to M2 .
No	INSTALL a new A/C pressure transducer. TEST the system for normal operation.

M2 CHECK THE A/C EVAPORATOR TEMPERATURE (EVAP_TEMP) HVAC PID

- Allow the vehicle exterior and interior to stabilize to the outside ambient temperature.
- Enter the following diagnostic mode on the scan tool: EVAP_TEMP HVAC PID .

Does the EVAP_TEMP HVAC PID read similar to the ambient temperature?

Yes	GO to M3 .
No	INSTALL a new Evaporator discharge air temperature sensor. TEST the system for normal operation.

M3 CHECK THE (A/C) SWITCH (CC_SW_AC) FCIM PID WITH THE A/C ON

- Enter the following diagnostic mode on the scan tool: CC_SW_AC FCIM PID .
- Select PANEL press the A/C button (indicator on) on the HVAC controls.

Does the CC_SW_AC FCIM PID read Active?

Yes	GO to M4 .
No	INSTALL a new FCIM . TEST the system for normal operation.

M4 CHECK THE AIR CONDITIONING REQUEST SIGNAL (AC_REQ) PCM PID WITH THE A/C ON

- Enter the following diagnostic mode on the scan tool: AC_REQ PCM PID .
- Select PANEL press the A/C button (indicator on) on the HVAC controls.

Does the AC_REQ PCM PID read ON?

Yes	For vehicles equipped with navigation, GO to M5 . For vehicles not equipped with navigation, GO to M6 .
No	GO to M16 .

M5 CHECK THE AIR CONDITIONING REQUEST SIGNAL (AC_REQ) PCM PID WITH MAX A/C OPERATION

- Enter the following diagnostic mode on the scan tool: AC_REQ PCM PID .
- Select MAX A/C on the navigation screen.

Does the AC_REQ PCM PID read ON?

Yes	GO to M6 .
No	INSTALL a new ACM . TEST the system for normal operation.

M6 CHECK THE AIR CONDITIONING COMPRESSOR COMMANDED STATE (ACC_CMD) PCM PID WITH THE A/C ON

- Enter the following diagnostic mode on the scan tool: ACC_CMD PCM PID .
- Select PANEL press the A/C button (indicator on) on the HVAC controls.

Does the ACC_CMD PCM PID read ON?

Yes	GO to M7 .
No	GO to M17 .

M7 CHECK THE VOLTAGE AT THE A/C COMPRESSOR CLUTCH FIELD COIL

- Ignition OFF.
- Disconnect: A/C Compressor Clutch Field Coil C100 .
- Start the engine.
- Select PANEL and A/C on the HVAC module.
- Measure the voltage between A/C compressor clutch field coil [C100](#) Pin 1, circuit CH401 (VT/WH), harness side and ground.

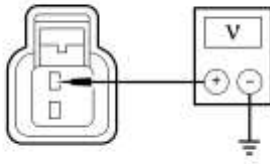

A0048576

Is the voltage greater than 10 volts?

Yes	GO to M8 .
No	CARRY OUT the A/C clutch relay component test. Refer to Wiring Diagrams Cell 149 for component testing. If the relay tests OK, GO to M11 .

M8 CHECK THE GROUND AT THE A/C COMPRESSOR CLUTCH FIELD COIL

- Ignition OFF.
- Measure the resistance between A/C compressor clutch field coil [C100](#) Pin 2, circuit GD123 (BK/GY), harness side and ground.

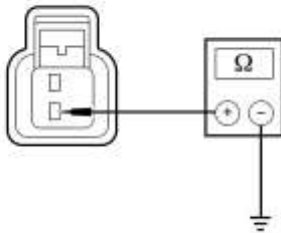

N0003085

Is the resistance less than 5 ohms?

Yes	GO to M9 .
No	REPAIR circuit GD123 (BK/GY) for an open. TEST the system for normal operation.

M9 CHECK THE A/C COMPRESSOR CLUTCH FIELD COIL

- Measure the resistance between the A/C compressor clutch field coil C100 terminals, component side.

Is the resistance 2-5 ohms?

Yes	GO to M10 .
No	INSTALL a new A/C compressor clutch field coil. TEST the system for normal operation.

M10 CHECK THE A/C COMPRESSOR CLUTCH FIELD COIL FOR A SHORT TO GROUND

- Measure the resistance between the A/C compressor clutch field coil C100 terminals, component side and ground.

Is the resistance greater than 10,000 ohms?

Yes	ADJUST the A/C compressor clutch gap. REFER to Air Conditioning (A/C) Clutch Air Gap Adjustment in this section. TEST the system for normal operation.
No	INSTALL a new A/C compressor clutch field coil. TEST the system for normal operation.

M11 CHECK THE VOLTAGE TO THE A/C CLUTCH RELAY SWITCH CONTACTS

- Ignition OFF.
- Disconnect: A/C Clutch Relay .
- Ignition ON.
- Measure the voltage between A/C clutch relay socket, circuit SBB25 (RD) and ground.

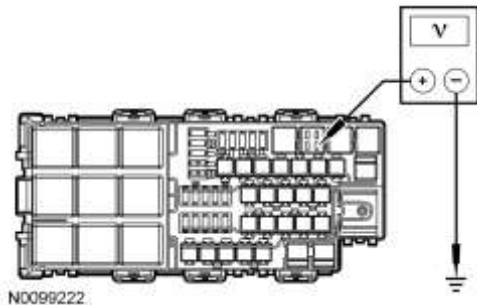

Is the voltage greater than 10 volts?

Yes	GO to M12 .
No	VERIFY Battery Junction Box (BJB) fuse 25 (10A) is OK. If OK, REPAIR circuit SBB25 (RD) for an open. TEST the system for normal operation. If not OK, REFER to the Wiring Diagrams manual to identify the possible causes of the circuit short.

M12 CHECK THE VOLTAGE TO THE A/C CLUTCH RELAY COIL

- Measure the voltage between ground and the A/C clutch relay socket, circuit CBB46 (WH/BU).

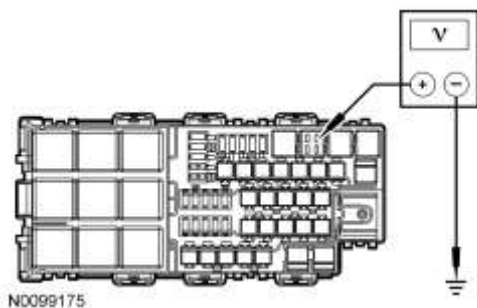

Is the voltage greater than 10 volts?

Yes	GO to M13 .
No	REPAIR circuit CBB46 (WH/BU) for an open. CLEAR the DTCs. REPEAT the self-test. TEST the system for normal operation.

M13 CHECK CIRCUIT CH401 (VT/WH) FOR AN OPEN

- Measure the resistance between A/C clutch relay socket, circuit CH401 (VT/WH) and A/C compressor clutch field coil [C100](#) Pin 1, circuit CH401 (VT/WH), harness side.

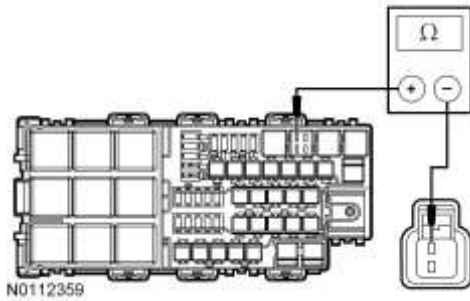

Is the resistance less than 5 ohms?

Yes	GO to M14 .
No	REPAIR circuit CH401 (VT/WH) for an open. CLEAR the DTCs. REPEAT the self-test. TEST the system for normal operation.

M14 CHECK CIRCUIT CH302 (WH/BN) FOR A SHORT TO VOLTAGE

- Ignition OFF.
- Disconnect: (5.0L, 5.4L) PCM C175B .
- Disconnect: (3.7L) PCM C1381B .
- Ignition ON.
- Measure the voltage between ground and:
 - For 5.0L and 5.4L, PCM [C175B](#) Pin 12, circuit CH302 (WH/BN), harness side.
 - For 3.7L, PCM [C1381B](#) Pin 12, circuit CH302 (WH/BN), harness side.

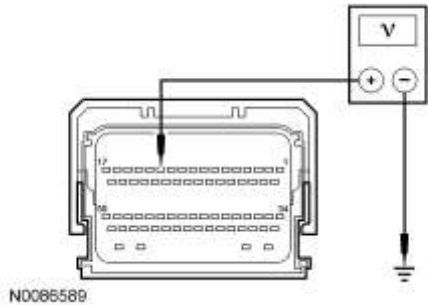

Is any voltage present?

Yes	REPAIR circuit CH302 (WH/BN) for a short to voltage. CLEAR the DTCs. REPEAT the self-test. TEST the system for normal operation.
No	GO to M15 .

M15 CHECK CIRCUIT CH302 (WH/BN) FOR AN OPEN

- Measure the resistance between A/C clutch relay socket, circuit CH302 (WH/BN) and:
 - For 5.0L and 5.4L, PCM [C175B](#) Pin 12, circuit CH302 (WH/BN), harness side.
 - For 3.7L, PCM [C1381B](#) Pin 12, circuit CH302 (WH/BN), harness side.

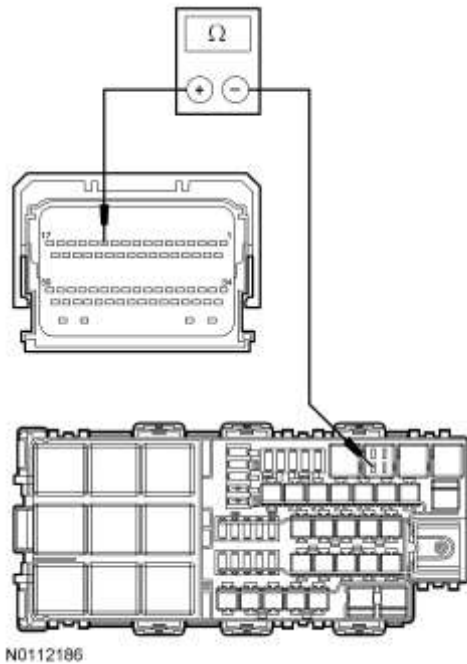

Is the resistance less than 5 ohms?

Yes	GO to M17 .
No	REPAIR circuit CH302 (WH/BN) for an open. CLEAR the DTCs. REPEAT the self-test. TEST the system for normal operation.

M16 CHECK THE HVAC MODULE CONNECTION

- Inspect the HVAC module connectors for:
 - corrosion.
 - pushed-out terminals.
 - damaged terminals.
- Connect and correctly seat all the HVAC module connectors.
- Clear the DTCs.
- Operate the system and verify the concern is still present.

Is the concern still present?

Yes	INSTALL a new HVAC module. REFER to Section 412-01 . TEST the system for normal operation. If the condition returns, GO to M13 .
No	The system is operating correctly at this time. The concern may have been caused by a loose or corroded connector. CLEAR the DTCs. REPEAT the self-test. TEST the system for normal operation.

M17 CHECK THE PCM CONNECTION

- Disconnect all the PCM connectors.
- Inspect the HVAC module connectors for:
 - corrosion.
 - pushed-out terminals.
 - damaged terminals.
- Connect and correctly seat all the PCM connectors.
- Clear the DTCs.
- Operate the system and verify the concern is still present.

Is the concern still present?

Yes	INSTALL a new PCM. TEST the system for normal operation.
No	The system is operating correctly at this time. The concern may have been caused by a loose or corroded connector.

Pinpoint Test N: The Air Conditioning (A/C) is Always On — A/C Compressor Does Not Cycle

Refer to Wiring Diagrams Cell [54](#) , Manual Climate Control System for schematic and connector information.

Refer to Wiring Diagrams Cell [55](#) , Automatic Climate Control System for schematic and connector information.

Normal Operation

Under normal operation, when the A/C button is pressed, a message is sent from the Front Controls Interface Module (FCIM) over the Medium Speed Controller Area Network (MS-CAN) bus to the HVAC module. The HVAC module then sends an A/C request message over the MS-CAN bus to the Instrument Cluster (IC) , then from the IC through the High Speed Controller Area Network (HS-CAN) bus to the PCM.

For **all vehicles equipped with navigation**, when MAX A/C is selected on the touch screen, the Audio Front Control Module (ACM) sends a message over the MS-CAN bus to the HVAC module that MAX A/C has been selected.

Voltage is provided to the A/C clutch relay coil and switch contacts. When A/C is requested and A/C line pressures allow, a ground is provided to the A/C clutch relay coil from the PCM, energizing the A/C clutch relay. When the PCM energizes the relay, voltage is supplied to the A/C clutch from the relay. Ground is supplied for the A/C clutch.

The evaporator discharge air temperature sensor is used for A/C compressor cycling. An accurate evaporator discharge air temperature is critical to prevent evaporator icing. The temperature measurement is used by the HVAC module to turn off the A/C compressor when the evaporator temperatures are cold enough to freeze the condensation. This prevents ice blockage of airflow over the evaporator core.

This pinpoint test is intended to diagnose the following:

- Wiring, terminals or connectors
- PCM
- Evaporator discharge air temperature sensor
- A/C control relay
- A/C compressor clutch air gap

PINPOINT TEST N : THE AIR CONDITIONING (A/C) IS ALWAYS ON — A/C COMPRESSOR DOES NOT CYCLE

NOTE: Before carrying out the following test, diagnose any HVAC, PCM or <u>IC</u> DTCs.	
N1 CHECK THE A/C EVAPORATOR TEMPERATURE (EVAP_TEMP) HVAC PID	
<ul style="list-style-type: none">• Ignition ON.• Allow the vehicle exterior and interior to stabilize to the outside ambient temperature.• Enter the following diagnostic mode on the scan tool: EVAP_TEMP HVAC PID .	
Does the EVAP_TEMP HVAC PID read similar to the ambient temperature?	
Yes	GO to N2 .
No	INSTALL a new evaporator discharge temperature sensor. TEST the system for normal operation.

N2 CHECK THE AIR CONDITIONING COMPRESSOR COMMANDED STATE (ACC_CMD) PCM PID WITH THE A/C OFF

- Start the engine.
- Enter the following diagnostic mode on the scan tool: ACC_CMD PCM PID .
- Select PANEL press the A/C button (indicator off) on the HVAC controls.

Does the ACC_CMD PCM PID read OFF?

Yes	GO to N3 .
No	GO to N6 .

N3 CHECK FOR VOLTAGE TO THE A/C COMPRESSOR CLUTCH FIELD COIL

- Ignition OFF.
- Disconnect: A/C Compressor Clutch Field Coil C100 .
- Ignition ON.
- Select the OFF position on the HVAC module.
- Measure the voltage between A/C compressor clutch field coil [C100](#) Pin 1, circuit CH401 (VT/WH), harness side and ground.

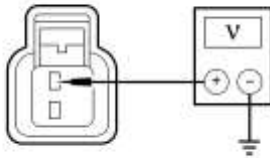

A0048576

Is the voltage greater than 10 volts?

Yes	CARRY OUT the A/C clutch relay component test. Refer to Wiring Diagrams Cell 149 for component testing. If the relay tests OK, GO to N4 .
No	ADJUST the A/C compressor clutch gap. REFER to Air Conditioning (A/C) Clutch Air Gap Adjustment in this section. TEST the system for normal operation.

N4 CHECK CIRCUIT CH401 (VT/WH) FOR A SHORT TO VOLTAGE

- Ignition OFF.
- Disconnect: A/C Clutch Relay .
- Ignition ON.
- Measure the voltage between A/C compressor clutch field coil [C100](#) Pin 1, circuit CH401 (VT/WH), harness side and ground.

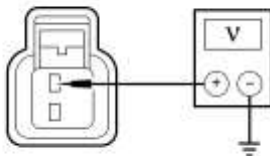

A0048576

Is the voltage greater than 10 volts?

Yes	REPAIR circuit CH401 (VT/WH) for a short to voltage. TEST the system for normal operation.
No	GO to N5

N5 CHECK CIRCUIT CH302 (WH/BN) FOR A SHORT TO GROUND

- Ignition OFF.
- Disconnect: (5.0L, 5.4L) PCM C175B .
- Disconnect: (3.7L) PCM C1381B .
- Measure the resistance between ground and:
 - **For 5.0L and 5.4L**, PCM [C175B](#) Pin 12, circuit CH302 (WH/BN), harness side.
 - **For 3.7L**, PCM [C1381B](#) Pin 12, circuit CH302 (WH/BN), harness side.

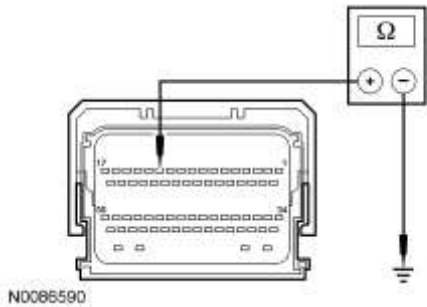

Is the resistance greater than 10,000 ohms?

Yes	GO to N6 .
No	REPAIR circuit CH302 (WH/BN) for a short to ground. CLEAR the DTCs. REPEAT the self-test. TEST the system for normal operation.

N6 CHECK THE PCM CONNECTION

- Disconnect all the PCM connectors.
- Inspect the HVAC module connectors for:
 - corrosion.
 - pushed-out terminals.
 - damaged terminals.
- Connect and correctly seat all the PCM connectors.
- Clear the DTCs.
- Operate the system and verify the concern is still present.

Is the concern still present?

Yes	INSTALL a new PCM. TEST the system for normal operation.
No	The system is operating correctly at this time. The concern may have been caused by a loose or corroded connector.

Pinpoint Test O: The Air Conditioning (A/C) is Always On — A/C Mode Always Commanded ON

Refer to Wiring Diagrams Cell [54](#) , Manual Climate Control System for schematic and connector information.

Refer to Wiring Diagrams Cell [55](#) , Automatic Climate Control System for schematic and connector information.

Normal Operation

Under normal operation, when the A/C button is pressed, a message is sent from the Front Controls Interface Module (FCIM) over the Medium Speed Controller Area Network (MS-CAN) bus to the HVAC module. The HVAC module then sends an A/C request message over the MS-CAN bus to the Instrument Cluster (IC) , then from the IC through the High Speed Controller Area Network (HS-CAN) bus to the PCM.

For **all vehicles equipped with navigation**, when MAX A/C is selected on the touch screen, the Audio Front Control Module (ACM) sends a message over the MS-CAN bus to the HVAC module that MAX A/C has been selected.

This pinpoint test is intended to diagnose the following:

- Wiring, terminals or connectors
- Front Controls Interface Module (FCIM)
- PCM
- HVAC module

PINPOINT TEST O : THE AIR CONDITIONING (A/C) IS ALWAYS ON — A/C MODE ALWAYS COMMANDED ON

NOTE: Before carrying out the following test, diagnose any HVAC, PCM or IC DTCs.

O1 CHECK THE AIR CONDITIONING SWITCH STATUS (CC_SW_AC) HVAC PID WITH THE A/C OFF

- Ignition ON.
- Enter the following diagnostic mode on the scan tool: CC_SW_AC HVAC PID .
- Select PANEL press the A/C button (indicator off) on the HVAC controls.

Does the CC_SW_AC HVAC PID read Inactive?

Yes	GO to O2 .
No	INSTALL a new Front Controls Interface Module (FCIM) . TEST the system for normal operation.

O2 CHECK THE AIR CONDITIONING REQUEST SIGNAL (AC_REQ) PCM PID WITH THE A/C OFF

- Enter the following diagnostic mode on the scan tool: AC_REQ PCM PID .
- Select PANEL press the A/C button (indicator off) on the HVAC controls.

Does the AC_REQ PCM PID read OFF?

Yes	GO to O5 .
No	GO to O3 .

O3 CHECK THE AIR CONDITIONING REQUEST SIGNAL (AC_REQ) PCM PID WITH HVAC MODULE DISCONNECTED

- Disconnect: HVAC Module C294A .
- Disconnect: HVAC Module C294B .
- Enter the following diagnostic mode on the scan tool: ACCS PCM PID .
- Observe the AC_REQ PCM PID.

Does the AC_REQ PCM PID read OFF?

Yes	GO to O4 .
No	GO to O5 .

O4 CHECK THE HVAC MODULE CONNECTION

- Inspect the HVAC module connectors for:
 - corrosion.
 - pushed-out terminals.
 - damaged terminals.
- Connect and correctly seat all the HVAC module connectors.
- Clear the DTCs.
- Operate the system and verify the concern is still present.

Is the concern still present?

Yes	INSTALL a new HVAC module. REFER to Section 412-01 . TEST the system for normal operation.
No	The system is operating correctly at this time. The concern may have been caused by a loose or corroded connector. CLEAR the DTCs. REPEAT the self-test. TEST the system for normal operation.

O5 CHECK THE PCM CONNECTION

- Disconnect all the PCM connectors.
- Inspect the HVAC module connectors for:
 - corrosion.
 - pushed-out terminals.
 - damaged terminals.
- Connect and correctly seat all the PCM connectors.
- Clear the DTCs.
- Operate the system and verify the concern is still present.

Is the concern still present?

Yes	INSTALL a new PCM. TEST the system for normal operation.
No	The system is operating correctly at this time. The concern may have been caused by a loose or corroded connector.

Pinpoint Test P: Temperature Control is Inoperative/Does Not Operate Correctly

Refer to Wiring Diagrams Cell [54](#) , Manual Climate Control System for schematic and connector information.

Refer to Wiring Diagrams Cell [55](#) , Automatic Climate Control System for schematic and connector information.

Normal Operation

Under normal operation, to rotate the temperature blend door actuator, the HVAC module supplies voltage and ground to the temperature blend door actuator through the door actuator motor circuits. To reverse the temperature blend door actuator rotation, the HVAC module reverses the voltage and ground circuits.

The temperature blend door actuator feedback resistors are supplied a ground from the HVAC module by the temperature blend door actuator return circuits and a 5-volt reference voltage on the temperature blend door actuator reference circuits. The HVAC module reads the voltage on the temperature blend door actuator feedback circuits to determine the temperature blend door actuator position by the position of the actuator feedback resistor wiper arm.

During an actuator calibration cycle, the HVAC module drives the temperature blend door until the door reaches both internal stops in the HVAC case. If the temperature blend door is temporarily obstructed or binding during a calibration cycle, the HVAC module may interpret this as the actual end of travel for the door. When this condition occurs and the HVAC module commands the actuator to its end of travel, the airflow may not be from the expected outlets.

DTC Description	Fault Trigger Conditions
<ul style="list-style-type: none"> B1081:00 — Left Temperature Damper Motor: No Sub Type Information 	<p>The module senses no changes in the feedback circuit when motor movement is commanded and no motor electrical DTCs are present, indicating an open circuit or mechanical failure.</p>
<ul style="list-style-type: none"> B1081:11 — Left Temperature Damper Motor: Circuit Short to Ground 	<p>The module senses lower the expected voltage on an actuator motor circuit when voltage is applied to drive the motor, indicating a short to ground.</p>
<ul style="list-style-type: none"> B1081:12 — Left Temperature Damper Motor: Circuit Short to Battery 	<p>The module senses higher than expected voltage on the actuator motor circuit when ground is applied to drive the motor, indicating a short to voltage.</p>
<ul style="list-style-type: none"> B1082:00 — Right Temperature Damper Motor: No Sub Type Information 	<p>The module senses no changes in the feedback circuit when motor movement is commanded and no motor electrical DTCs are present, indicating an open circuit or mechanical failure.</p>
<ul style="list-style-type: none"> B1082:11 — Right Temperature Damper Motor: Circuit Short to Ground 	<p>The module senses lower than expected voltage on an actuator motor circuit when voltage is applied to drive the motor, indicating a short to ground.</p>
<ul style="list-style-type: none"> B1082:12 — Right Temperature Damper Motor: Circuit Short to Battery 	<p>The module senses higher than expected voltage on the actuator motor circuit when ground is applied to drive the motor, indicating a short to voltage.</p>
<ul style="list-style-type: none"> B11E5:11 — Left HVAC Damper Position Sensor: Circuit Short to Ground 	<p>The module senses lower than expected voltage on the actuator feedback circuit, indicating a short to ground.</p>
<ul style="list-style-type: none"> B11E5:15 — Left HVAC Damper Position Sensor: Circuit Short to Battery or Open 	<p>The module senses higher than expected voltage on the actuator feedback circuit, indicating an open circuit or a short to voltage.</p>
<ul style="list-style-type: none"> B11E6:11 — Right HVAC Damper Position Sensor: Circuit Short to Ground 	<p>The module senses lower than expected voltage on the actuator feedback circuit, indicating a short to ground.</p>
<ul style="list-style-type: none"> B11E6:15 — Right HVAC Damper Position Sensor: Circuit Short to Battery or Open 	<p>The module senses higher than expected voltage on the actuator feedback circuit, indicating an open circuit or a short to voltage.</p>

This pinpoint test is intended to diagnose the following:

- Wiring, terminals or connectors
- Temperature blend door actuator(s)

- HVAC module
- Stuck or bound linkage or door(s)

PINPOINT TEST P : TEMPERATURE CONTROL IS INOPERATIVE/DOES NOT OPERATE CORRECTLY

P1 CHECK THE HVAC MODULE FOR DTCS

- Ignition ON.
- Check the HVAC module for DTCS.

Are any DTCS present?

Yes	For DTC B1081:00 or B1082:00 , INSPECT for binding/damaged linkage or door. REPAIR as necessary. If no condition is found, GO to P3 . For DTC B1081:12 or B1082:12 , GO to P2 . For DTC B1081:11 or B1082:11 , GO to P4 . For DTC B11E5:15 or B11E6:15 , GO to P6 . For DTC B11E5:11 or B11E6:11 , GO to P10 .
No	INSPECT for broken linkage or door. REPAIR as necessary. If no condition is found, GO to P13 .

P2 CHECK THE ACTUATOR MOTOR DRIVE CIRCUITS FOR A SHORT TO POWER

- Ignition OFF.
- Disconnect: HVAC Module C294A .
- Disconnect: HVAC Module C294B .
- Ignition ON.
- Measure the voltage between ground and:
 - For DTC **B1081:12**, HVAC module [C294A](#) Pin 18, circuit CH238 (YE/OG), harness side.
 - For DTC **B1082:12**, HVAC module [C294B](#) Pin 14, circuit CH212 (BU/OG), harness side.

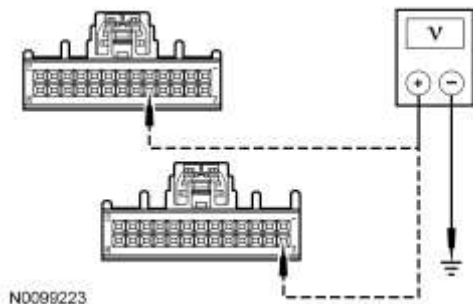

- Measure the voltage between ground and:
 - For DTC **B1081:12**, HVAC module [C294A](#) Pin 19, circuit CH239 (BU/WH), harness side.
 - For DTC **B1082:12**, HVAC module [C294B](#) Pin 15, circuit CH213 (BN/GN), harness side.

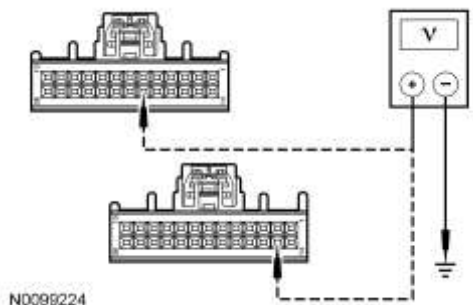

Are any voltages present?

Yes	REPAIR the circuit(s) for a short to power. CLEAR the DTCS. REPEAT the self-test. TEST the system for normal operation.
------------	---

No	GO to P5 .
----	----------------------------

P3 CHECK THE ACTUATOR MOTOR DRIVE CIRCUITS FOR AN OPEN

NOTE: Due to limited connector accessibility, before carrying out this test step, visually inspect the wiring between the HVAC module and actuator for opens or shorts. If no damage is visually evident, proceed with the test.

- Ignition OFF.
- Disconnect: HVAC Module C294A .
- Disconnect: HVAC Module C294B .
- Disconnect: **For DTC B1081:00**, LH Temperature Blend Door Actuator C2091 .
- Disconnect: **For DTC B1082:00**, RH Temperature Blend Door Actuator C2092 .
- Measure the resistance between:
 - **For DTC B1081:00**, HVAC module [C294A](#) Pin 18, circuit CH238 (YE/OG), harness side and LH temperature blend door actuator [C2091](#) Pin 6, circuit CH238 (YE/OG), harness side.
 - **For DTC B1082:00**, HVAC module [C294B](#) Pin 14, circuit CH212 (BU/OG), harness side and RH temperature blend door actuator [C2092](#) Pin 6, circuit CH212 (BU/OG), harness side.

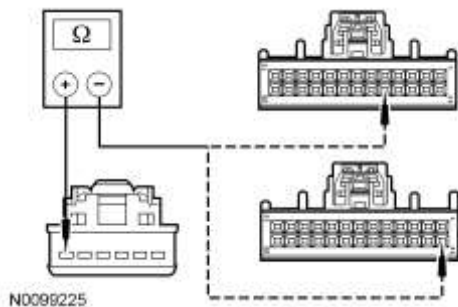

- Measure the resistance between:
 - **For DTC B1081:00**, HVAC module [C294A](#) Pin 19, circuit CH239 (BU/WH), harness side and LH temperature blend door actuator [C2091](#) Pin 1, circuit CH239 (BU/WH), harness side.
 - **For DTC B1082:00**, HVAC module [C294B](#) Pin 15, circuit CH213 (BN/GN), harness side and RH temperature blend door actuator [C2092](#) Pin 1, circuit CH213 (BN/GN), harness side.

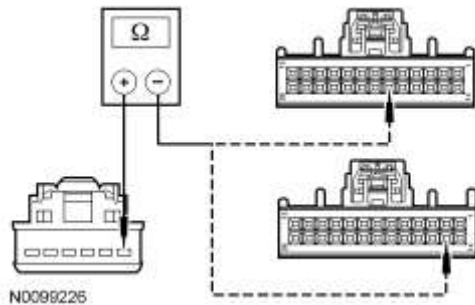

Are the resistances less than 5 ohms?

Yes	GO to P13 .
No	REPAIR the circuit(s) for an open. CLEAR the DTCs. REPEAT the self-test. TEST the system for normal operation.

P4 CHECK THE ACTUATOR MOTOR DRIVE CIRCUITS FOR A SHORT TO GROUND

- Ignition OFF.
- Disconnect: HVAC Module C294A .
- Disconnect: HVAC Module C294B .
- Measure the resistance between ground and:
 - **For DTC B1081:11**, HVAC module [C294A](#) Pin 18, circuit CH238 (YE/OG), harness side.
 - **For DTC B1082:11**, HVAC module [C294B](#) Pin 14, circuit CH212 (BU/OG), harness side.

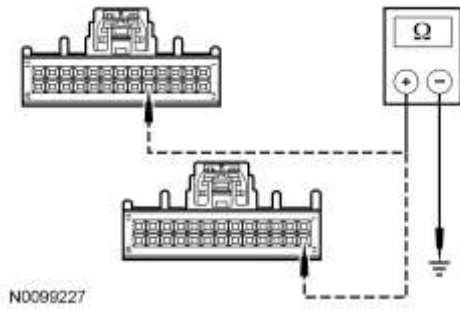

- Measure the resistance between ground and:
 - For DTC B1081:11, HVAC module [C294A](#) Pin 19, circuit CH239 (BU/WH), harness side.
 - For DTC B1082:11, HVAC module [C294B](#) Pin 15, circuit CH213 (BN/GN), harness side.

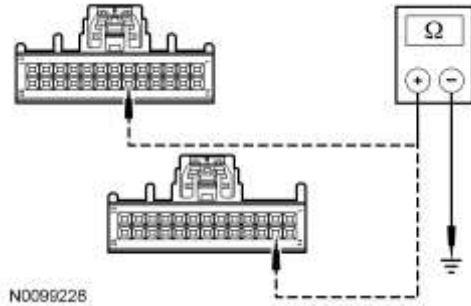

Are the resistances greater than 10,000 ohms?

Yes	GO to P5 .
No	REPAIR the circuit(s) for a short to ground. CLEAR the DTCs. REPEAT the self-test. TEST the system for normal operation.

P5 CHECK THE ACTUATOR MOTOR DRIVE CIRCUITS FOR A SHORT TOGETHER

NOTE: Due to limited connector accessibility, before carrying out this test step, visually inspect the wiring between the HVAC module and actuator for opens or shorts. If no damage is visually evident, proceed with the test.

- Ignition OFF.
- Disconnect: For DTC B1081:11, LH Temperature Blend Door Actuator C2091 .
- Disconnect: For DTC B1082:11, RH Temperature Blend Door Actuator C2092 .
- For DTC B1081:11

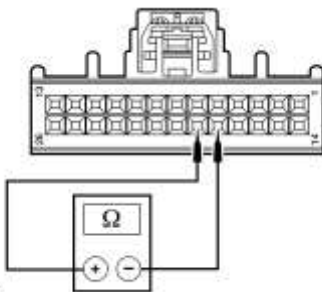

NOTE: For DTC B1081:11.

Measure the resistance between HVAC module [C294A](#) Pin 19, circuit CH239 (BU/WH), harness side and HVAC module [C294A](#) Pin 18, circuit CH238 (YE/OG), harness side.

- For DTC B1082:11

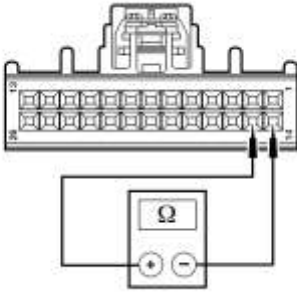

N0099230

NOTE: For DTC B1082:11.

Measure the resistance between HVAC module [C294B](#) Pin 15, circuit CH213 (BN/GN), harness side and HVAC module [C294B](#) Pin 14, circuit CH212 (BU/OG), harness side.

Is the resistance greater than 10,000 ohms?

Yes	GO to P13 .
No	REPAIR circuit(s) for a short together. CLEAR the DTCs. REPEAT the self-test. TEST the system for normal operation.

P6 CHECK CIRCUIT VH441 (WH/BN) OR VH440 (BU/BN) FOR AN OPEN

NOTE: Due to limited connector accessibility, before carrying out this test step, visually inspect the wiring between the HVAC module and actuator for opens or shorts. If no damage is visually evident, proceed with the test.

- Ignition OFF.
- Disconnect: HVAC Module C294A .
- Disconnect: HVAC Module C294B .
- Disconnect: **For DTC B11E5:15**, LH Temperature Blend Door Actuator C2091 .
- Disconnect: **For DTC B11E6:15**, RH Temperature Blend Door Actuator C2092 .
- Measure the resistance between the following:
 - **For DTC B11E5:15**, HVAC module [C294A](#) Pin 7, circuit VH440 (BU/BN), harness side and LH temperature blend door actuator [C2091](#) Pin 4, circuit VH440 (BU/BN), harness side.
 - **For DTC B11E6:15**, HVAC module [C294B](#) Pin 24, circuit VH441 (WH/BN), harness side and RH temperature blend door actuator [C2092](#) Pin 4, circuit VH441 (WH/BN), harness side.

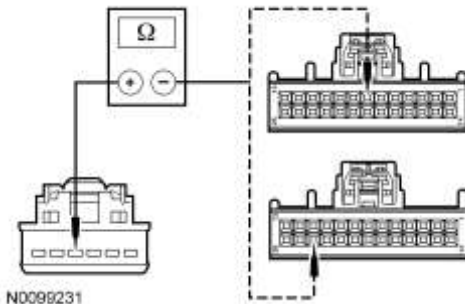

N0099231

Is the resistance less than 5 ohms?

Yes	GO to P7 .
No	REPAIR circuit VH441 (WH/BN) or VH440 (BU/BN) for an open. CLEAR the DTCs. REPEAT the self-test. TEST the system for normal operation.

P7 CHECK CIRCUIT VH440 (BU/BN) OR VH441 (WH/BN) FOR A SHORT TO POWER

- Ignition ON.
- Measure the voltage between ground and the following:
 - **For DTC B11E5:15**, HVAC module [C294A](#) Pin 7, circuit VH440 (BU/BN), harness side.
 - **For DTC B11E6:15**, HVAC module [C294B](#) Pin 24, circuit VH441 (WH/BN), harness side.

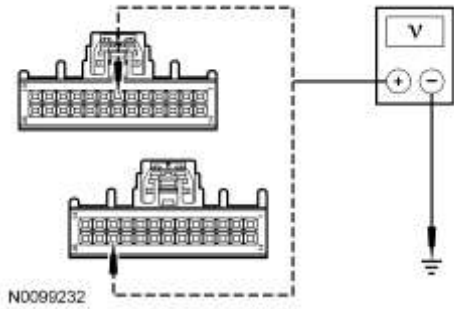

Is any voltage present?

Yes	REPAIR circuits VH441 (WH/BN) or VH440 (BU/BN) for a short to power. CLEAR the DTCs. REPEAT the self-test. TEST the system for normal operation.
No	GO to P8 .

P8 CHECK CIRCUIT LH111 (BN/WH) FOR A SHORT TO CIRCUIT VH441 (WH/BN) OR VH440 (BU/BN)

- Ignition OFF.
- Measure the resistance between HVAC module [C294A](#) Pin 3, circuit LH111 (BN/WH) and the following:
 - For DTC B11E5:15, HVAC module [C294A](#) Pin 7, circuit VH440 (BU/BN), harness side.
 - For DTC B11E6:15, HVAC module [C294B](#) Pin 24, circuit VH441 (WH/BN), harness side.

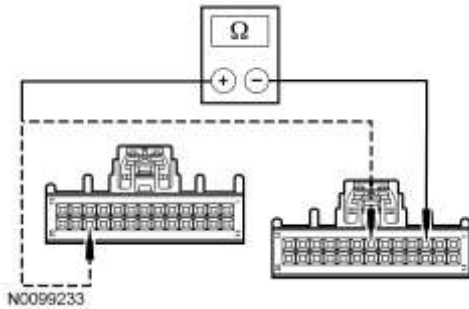

Is the resistance greater than 10,000 ohms?

Yes	GO to P9 .
No	REPAIR circuits LH111 (BN/WH) and VH441 (WH/BN) or VH440 (BU/BN) for a short together. CLEAR the DTCs. REPEAT the self-test. TEST the system for normal operation.

P9 CHECK THE ACTUATOR RETURN CIRCUIT RH111 (GY/BU) FOR AN OPEN

- Measure the resistance between HVAC module [C294A](#) Pin 4, circuit RH111 (GY/BU) and the following:
 - For DTC B11E5:15, LH temperature blend door actuator [C2091](#) Pin 2, circuit RH111 (GY/BU), harness side.
 - For DTC B11E6:15, RH temperature blend door actuator [C2092](#) Pin 2, circuit RH111 (GY/BU), harness side.

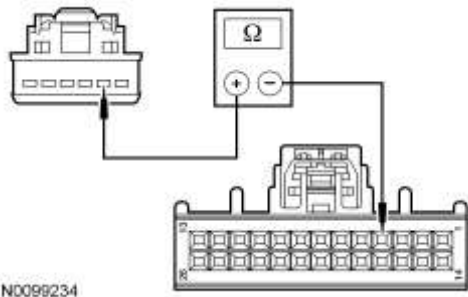

Is the resistance less than 5 ohms?

Yes	GO to P13 .
No	REPAIR circuit RH111 (GY/BU) for an open. CLEAR the DTCs. REPEAT the self-test. TEST the system for normal operation.

P10 CHECK CIRCUIT VH440 (BU/BN) OR VH441 (WH/BN) FOR A SHORT TO GROUND

- Ignition OFF.
- Disconnect: HVAC Module C294A .
- Disconnect: HVAC Module C294B .
- Measure the resistance between ground and the following:
 - For DTC B11E5:11, HVAC module [C294A](#) Pin 7, circuit VH440 (BU/BN), harness side.
 - For DTC B11E6:11, HVAC module [C294B](#) Pin 24, circuit VH441 (WH/BN), harness side.

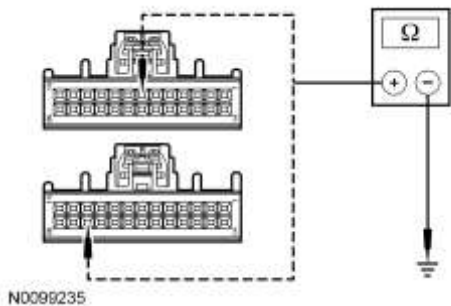

Are the resistances greater than 10,000 ohms?

Yes	GO to P11 .
No	REPAIR circuit VH441 (WH/BN) or VH440 (BU/BN) for a short to ground. CLEAR the DTCs. REPEAT the self-test. TEST the system for normal operation.

P11 CHECK CIRCUIT RH111 (GY/BU) FOR A SHORT TO CIRCUIT VH441 (WH/BN) OR VH440 (BU/BN)

NOTE: Due to limited connector accessibility, before carrying out this test step, visually inspect the wiring between the HVAC module and actuator for opens or shorts. If no damage is visually evident, proceed with the test.

- Disconnect: For DTC B11E5:11, LH Temperature Blend Door Actuator C2091 .
- Disconnect: For DTC B11E6:11, RH Temperature Blend Door Actuator C2092 .
- Measure the resistance between HVAC module [C294A](#) Pin 4, circuit RH111 (GY/BU) and the following:
 - For DTC B11E5:11, HVAC module [C294A](#) Pin 7, circuit VH440 (BU/BN), harness side.
 - For DTC B11E6:11, HVAC module [C294B](#) Pin 24, circuit VH441 (WH/BN), harness side.

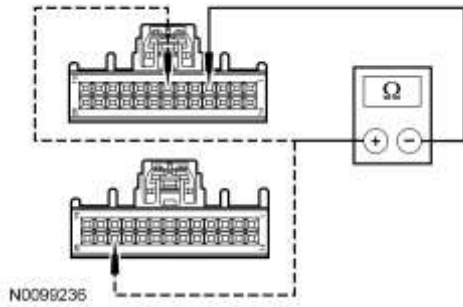

Is the resistance greater than 10,000 ohms?

Yes	GO to P12 .
No	REPAIR circuits RH111 (GY/BU) and VH441 (WH/BN) or VH440 (BU/BN) for a short together. CLEAR the DTCs. REPEAT the self-test. TEST the system for normal operation.

P12 CHECK CIRCUIT LH111 (BN/WH) FOR AN OPEN

- Measure the resistance between HVAC module [C294A](#) Pin 3, circuit LH111 (BN/WH) and the following:
 - For DTC B11E5:11**, LH temperature blend door actuator [C2091](#) Pin 3, circuit LH111 (BN/WH), harness side.
 - For DTC B11E6:11**, RH temperature blend door actuator [C2092](#) Pin 3, circuit LH111 (BN/WH), harness side.

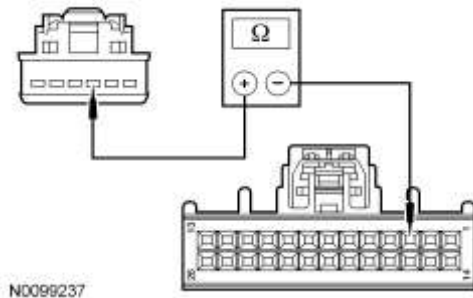

Are the resistances less than 5 ohms?

Yes	GO to P13 .
No	REPAIR circuit LH111 (BN/WH) for an open. CLEAR the DTCs. REPEAT the self-test. TEST the system for normal operation.

P13 CHECK THE ACTUATOR CONNECTION

- Disconnect the actuator connector.
- Check for:
 - corrosion.
 - pushed-out terminals.
 - damaged terminals.
- Connect and correctly seat the actuator connector.
- Clear the DTCs.
- Operate the system and verify the concern is still present.

Is the concern still present?

Yes	CARRY OUT the Temperature Blend Door Actuator component test in this section. If the actuator tests OK, GO to P14 .
------------	---

No	The system is operating correctly at this time. The concern may have been caused by a loose or corroded connector. CLEAR the DTCs. TEST the system for normal operation.
-----------	--

P14 MODULE ACTUATOR POSITION CALIBRATION

NOTE: *The purpose of the module actuator position calibration is to allow the HVAC module to reinitialize and calibrate the actuator stop points. To carry out the calibration, follow the steps below.*

- Ignition OFF.
 - Inspect the HVAC module connectors for:
 - corrosion.
 - pushed-out terminals.
 - damaged terminals.
 - Connect and correctly seat all the HVAC module connectors.
 - Ignition ON.
 - Clear the DTCs.
 - Select any position except OFF
 - **NOTE:** *The HVAC module will now initialize and calibrate the actuators. Calibration of the actuators will take approximately 30 seconds.*
- Operate the system and verify the concern is still present.

Is the concern still present?

Yes	INSTALL a new HVAC module. REFER to Section 412-01 . TEST the system for normal operation.
No	The system is now operating correctly at this time. The concern may have been caused by a foreign object in the HVAC case or temporary binding that restricted actuator door travel. CHECK any actuator external linkage. If condition recurs, INSPECT actuator linkage and door for binding and CHECK HVAC case for foreign objects.

Pinpoint Test Q: The Blower Motor is Inoperative

Refer to Wiring Diagrams Cell [54](#) , Manual Climate Control System for schematic and connector information.

Refer to Wiring Diagrams Cell [55](#) , Automatic Climate Control System for schematic and connector information.

Normal Operation

Under normal operation, voltage is provided to the blower motor relay coil and switch contacts. When the blower motor relay coil receives a ground from the HVAC module, the relay coil is energized and voltage is delivered from the blower motor relay to the blower motor and the blower motor speed control. A varying ground for the blower motor is provided from the blower motor speed control. Ground is provided for the blower motor speed control. The HVAC module sends a Pulse Width Modulated (PWM) signal to the blower motor speed control to vary the blower speed.

- DTC B10AF:12 (Blower Fan Relay: Circuit Short to Battery) — The module senses voltage on the relay coil ground circuit when the relay is grounded by the HVAC module, indicating a short directly to voltage.
- DTC B10AF:13 (Blower Fan Relay: Circuit Open) — The module senses no voltage on the relay coil ground circuit when the relay is not grounded by the HVAC module, indicating an open.
- DTC B10B9:14 (Blower Control: Circuit Short to Ground or Open) — The module senses no voltage on the blower motor control PWM circuit, indicating an open or a short directly to ground.

This pinpoint test is intended to diagnose the following:

- Fuse(s)
- Wiring, terminals or connectors
- Blower motor relay
- Blower motor speed control

- HVAC module
- Blower motor

PINPOINT TEST Q : THE BLOWER MOTOR IS INOPERATIVE

Q1 CHECK THE HVAC MODULE FOR DTCS

- Ignition ON.
- Check the HVAC module for DTCS.

Are any DTCS present?

Yes	<p>For DTC B10AF:12, REPAIR circuit CH123 (VT/GN) for a short to voltage. CLEAR the DTCS. REPEAT the self-test. TEST the system for normal operation.</p> <p>For DTC B10AF:13, CARRY OUT the Blower Motor Relay component test. Refer to Wiring Diagrams Cell 149 for component testing. If the relay tests OK, GO to Q2.</p> <p>For DTC B10B9:14, GO to Q9.</p>
No	GO to Q3 .

Q2 CHECK THE RELAY COIL SUPPLY VOLTAGE

- Ignition OFF.
- Disconnect: Blower Motor Relay .
- Ignition ON.
- Measure the voltage between blower motor relay socket pin 86, circuit CBP45 (YE) and ground.

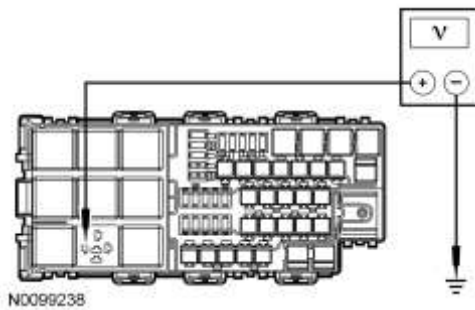

Is the voltage greater than 10 volts?

Yes	REPAIR circuit CH123 (VT/GN) for an open. CLEAR the DTCS. REPEAT the self-test. TEST the system for normal operation.
No	VERIFY Smart Junction Box (SJB) fuse 45 (5A) is OK. If OK, REPAIR circuit CBP45 (YE) for an open. TEST the system for normal operation. If not OK, REFER to the Wiring Diagrams manual to identify the possible causes of the circuit short.

Q3 VERIFY THE BLOWER MOTOR OPERATION

- Select PANEL on the HVAC module. Adjust the blower motor setting to LO and then to HI.

Is the blower motor inoperative in all settings?

Yes	GO to Q4 .
No	GO to Pinpoint Test R.

Q4 CHECK FOR VOLTAGE TO THE BLOWER MOTOR

- Ignition OFF.

- Disconnect: Blower Motor C2066 .
- Ignition ON.
- Measure the voltage between blower motor [C2066](#) Pin 2, circuit CH402 (YE/GN), harness side and ground.

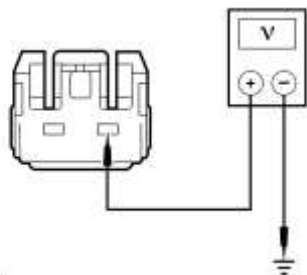

N0089554

Is the voltage greater than 10 volts?

Yes	GO to Q5 .
No	GO to Q11 .

Q5 CHECK FOR VOLTAGE TO THE BLOWER MOTOR SPEED CONTROL

- Ignition OFF.
- Disconnect: Blower Motor Speed Control C2185 .
- Ignition ON.
- Measure the voltage between blower motor speed control [C2185](#) Pin 4, circuit CH402 (YE/GN), harness side and ground.

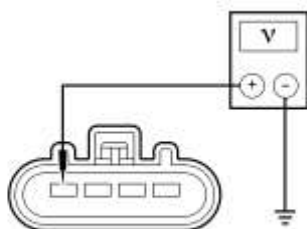

N0001798

Is the voltage greater than 10 volts?

Yes	GO to Q6 .
No	REPAIR circuit CH402 (YE/GN) for an open. TEST the system for normal operation.

Q6 CHECK CIRCUIT GD114 (BK/BU) FOR AN OPEN

- Ignition OFF.
- Measure the resistance between blower motor speed control [C2185](#) Pin 1, circuit GD114 (BK/BU), harness side and ground.

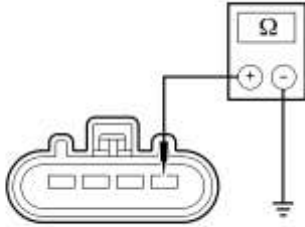

N0001799

Is the resistance less than 5 ohms?

Yes	GO to Q7 .
No	REPAIR circuit GD114 (BK/BU) for an open. TEST the system for normal operation.

Q7 CHECK CIRCUIT CH426 (YE/OG) FOR AN OPEN

- Measure the resistance between blower motor [C2066](#) Pin 1, circuit CH426 (YE/OG), harness side and blower motor speed control [C2185](#) Pin 2, circuit CH426 (YE/OG), harness side.

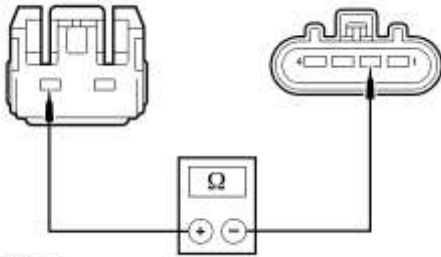

N0069558

Is the resistance less than 5 ohms?

Yes	GO to Q8 .
No	REPAIR circuit CH426 (YE/OG) for an open. TEST the system for normal operation.

Q8 CHECK THE BLOWER MOTOR

- Connect: Blower Motor C2066 .
- Connect a fused jumper lead between blower motor speed control [C2185](#) Pin 2, circuit CH426 (YE/OG), harness side and [C2185](#) Pin 1, circuit GD114 (BK/BU), harness side.

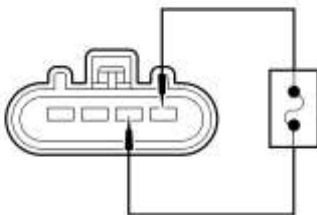

N0001800

- Ignition ON.

Does the blower motor operate?

Yes	INSTALL a new blower motor speed control. TEST the system for normal operation. If the blower motor is still inoperative, INSTALL a new HVAC module. TEST the system for normal operation.
No	INSTALL a new blower motor. TEST the system for normal operation.

Q9 CHECK CIRCUIT VH101 (WH/VT) FOR A SHORT TO GROUND

- Ignition OFF.
- Disconnect: HVAC Module C294A .
- Measure the resistance between blower motor speed control [C2185](#) Pin 3, circuit VH101 (WH/VT), harness side and ground.

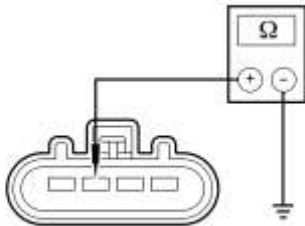

N0001801

Is the resistance greater than 10,000 ohms?

Yes	GO to Q10 .
No	REPAIR circuit VH101 (WH/VT) for a short to ground. TEST the system for normal operation.

Q10 CHECK CIRCUIT VH101 (WH/VT) FOR AN OPEN

- Ignition OFF.
- Measure the resistance between blower motor speed control [C2185](#) Pin 3, circuit VH101 (WH/VT), harness side and HVAC module [C294A](#) Pin 26, circuit VH101 (WH/VT), harness side.

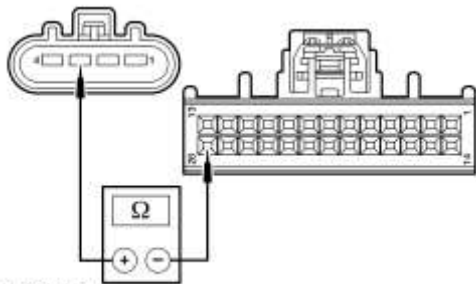

N0099239

Is the resistance less than 5 ohms?

Yes	INSTALL a new blower motor speed control. TEST the system for normal operation. If the blower motor is still inoperative, INSTALL a new HVAC module. TEST the system for normal operation.
No	REPAIR circuit VH101 (WH/VT) for an open. TEST the system for normal operation.

Q11 CHECK CIRCUIT CH402 (YE/GN) FOR AN OPEN

- Ignition OFF.
- Disconnect: Blower Motor Relay .
- Measure the resistance between blower motor relay socket pin 87, circuit CH402 (YE/GN) and blower motor [C2066](#) Pin 2, circuit CH402 (YE/GN), harness side.

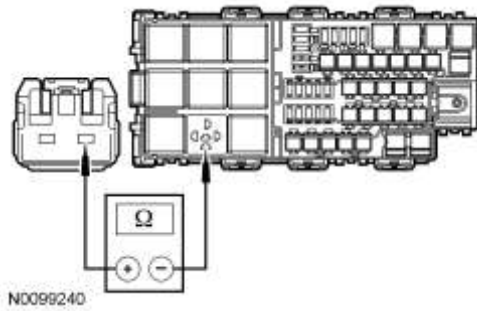

Is the resistance less than 5 ohms?

Yes	GO to Q12 .
No	REPAIR circuit CH402 (YE/GN) for an open. TEST the system for normal operation.

Q12 CHECK THE RELAY SWITCH POWER CIRCUIT FOR AN OPEN

- Measure the voltage between blower motor relay socket pin 30, circuit SBB04 (GN/RD) and ground.

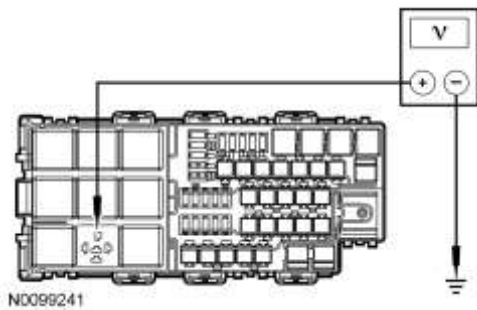

Is the voltage greater than 10 volts?

Yes	GO to Q13 .
No	VERIFY Battery Junction Box (BJB) fuse 4 (30A) is OK. If OK, REPAIR circuit SBB04 (GN/RD) for an open. TEST the system for normal operation. If not OK, REFER to the Wiring Diagrams manual to identify the possible causes of the circuit short.

Q13 CHECK THE MODULE OUTPUT

NOTICE: The following step uses the Test Light to simulate normal circuit loads. Use only the Test Light recommended in the Special Tools table at the beginning of this section or equivalent. To avoid connector terminal damage, use the Flex Probe Kit for the Test Light probe connection to the vehicle. Do not use the Test Light probe directly on any connector.

- Ignition ON.
- With the engine running, connect a 12-volt test lamp between blower motor relay socket pin 86, circuit CBP45 (YE) and socket pin 85, circuit CH123 (VT/GN).

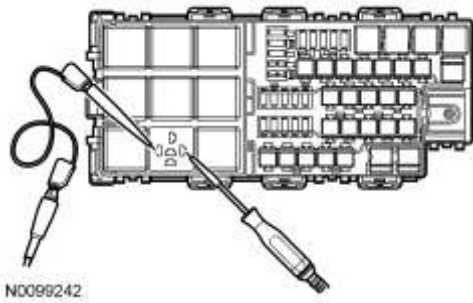

Does the test lamp illuminate?

Yes	INSTALL a new blower motor relay. TEST the system for normal operation.
No	GO to Q14 .

Q14 CHECK THE HVAC MODULE CONNECTION

- Inspect the HVAC module connectors for:
 - corrosion.
 - pushed-out terminals.
 - damaged terminals.
- Connect and correctly seat all the HVAC module connectors.
- Clear the DTCs.
- Operate the system and verify the concern is still present.

Is the concern still present?

Yes	INSTALL a new HVAC module. REFER to Section 412-01 . TEST the system for normal operation.
No	The system is operating correctly at this time. The concern may have been caused by a loose or corroded connector. CLEAR the DTCs. REPEAT the self-test. TEST the system for normal operation.

Pinpoint Test R: The Blower Motor Does Not Operate Correctly

Refer to Wiring Diagrams Cell [54](#) , Manual Climate Control System for schematic and connector information.

Refer to Wiring Diagrams Cell [55](#) , Automatic Climate Control System for schematic and connector information.

Normal Operation

Under normal operation, voltage is provided to the blower motor relay coil and switch contacts. When the blower motor relay coil receives a ground from the HVAC module, the relay coil is energized and voltage is delivered from the blower motor relay to the blower motor and the blower motor speed control. A varying ground for the blower motor is provided from the blower motor speed control. Ground is provided for the blower motor speed control. The HVAC module sends a Pulse Width Modulated (PWM) signal to the blower motor speed control to vary the blower speed.

- DTC B10AF:11 (Blower Fan Relay: Circuit Short to Ground) — The module senses ground on the relay coil ground circuit when the relay is not grounded by the HVAC module, indicating a short directly to ground.
- DTC B10B9:12 (Blower Control: Circuit Short to Battery) — The module senses excessive voltage on the blower motor control PWM circuit, indicating a short directly to voltage.

This pinpoint test is intended to diagnose the following:

- Wiring, terminals or connectors
- Blower motor speed control
- HVAC module

PINPOINT TEST R : THE BLOWER MOTOR DOES NOT OPERATE CORRECTLY

R1 CHECK THE HVAC MODULE FOR DTCS

- Ignition ON.
- Check the HVAC module for DTCS.

Are any DTCS present?

Yes	For DTC B10AF:11 , REPAIR circuit CH123 (VT/GN) for a short to ground. CLEAR the DTCS. REPEAT the self-test. TEST the system for normal operation. For DTC B10B9:12 , GO to R4 .
No	GO to R2 .

R2 VERIFY THE BLOWER MOTOR OPERATION

- Ignition ON.
- Select PANEL on the HVAC module. Adjust the blower motor setting to LO and then to HI then press the POWER button on the HVAC module (OFF).

Does the blower motor operate at any setting and/or turn OFF?

Yes	If the blower motor operates always in HI, GO to R3 . If the blower motor is always ON, GO to R6 . All other symptoms, INSTALL a new blower motor speed control. TEST the system for normal operation. If the blower motor still does not operate correctly, GO to R8 .
No	GO to Pinpoint Test Q .

R3 CHECK CIRCUIT CH426 (YE/OG) FOR A SHORT TO GROUND

- Ignition OFF.
- Disconnect: Blower Motor Speed Control C2185 .
- Ignition ON.

Does the blower motor operate?

Yes	REPAIR circuit CH426 (YE/OG) for a short to ground. TEST the system for normal operation.
No	INSTALL a new blower motor speed control. TEST the system for normal operation.

R4 CHECK CIRCUIT VH101 (WH/VT) FOR A SHORT TO VOLTAGE

- Ignition OFF.
- Disconnect: HVAC Module C294A .
- Ignition ON.
- Measure the voltage between blower motor speed control [C2185](#) Pin 3, circuit VH101 (WH/VT), harness side and ground.

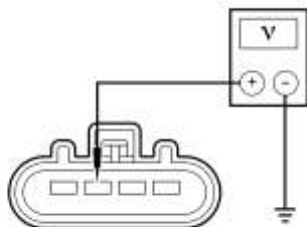

N0001804

Is any voltage present?

Yes	REPAIR circuit VH101 (WH/VT) for a short to voltage. TEST the system for normal operation.
No	GO to R5 .

R5 CHECK CIRCUIT VH101 (WH/VT) FOR AN OPEN

- Ignition OFF.
- Measure the resistance between blower motor speed control [C2185](#) Pin 3, circuit VH101 (WH/VT), harness side and HVAC module [C294A](#) Pin 26, circuit VH101 (WH/VT), harness side.

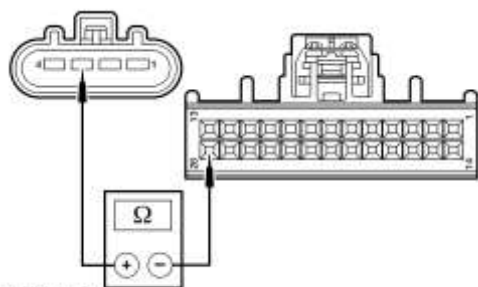

N0099239

Is the resistance less than 5 ohms?

Yes	INSTALL a new blower motor speed control. TEST the system for normal operation.
No	REPAIR circuit VH101 (WH/VT) for an open. TEST the system for normal operation.

R6 CHECK CIRCUIT CH123 (VT/GN) FOR A SHORT TO GROUND

- Ignition OFF.
- Disconnect: Blower Motor Relay .
- Disconnect: HVAC Module C294A .
- Measure the resistance between blower motor relay socket pin 85, circuit CH123 (VT/GN) and ground.

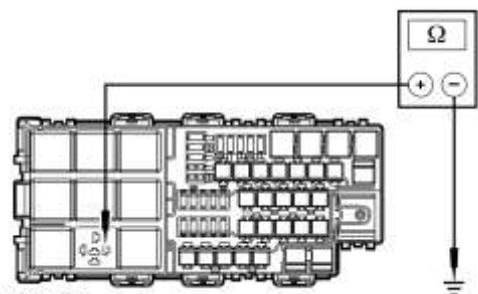

N0099243

Is the resistance greater than 10,000 ohms?

Yes	GO to R7 .
No	REPAIR circuit CH123 (VT/GN) for a short to ground. TEST the system for normal operation.

R7 CHECK CIRCUIT CH402 (YE/GN) FOR A SHORT TO VOLTAGE

- Ignition OFF.
- Disconnect: Blower Motor C2066 .
- Ignition ON.
- Measure the voltage between blower motor [C2066](#) Pin 2, circuit CH402 (YE/GN), harness side and ground.

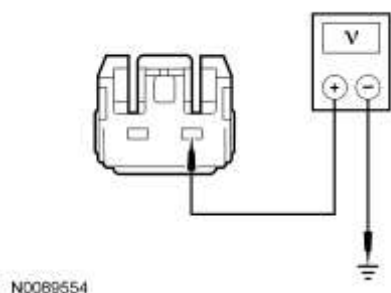

Is any voltage present?

Yes	REPAIR circuit CH402 (YE/GN) for a short to voltage. TEST the system for normal operation.
No	INSTALL a new blower motor speed control. TEST the system for normal operation. If the blower motor still does not operate correctly, GO to R8 .

R8 CHECK THE HVAC MODULE CONNECTION

- Inspect the HVAC module connectors for:
 - corrosion.
 - pushed-out terminals.
 - damaged terminals.
- Connect and correctly seat all the HVAC module connectors.
- Clear the DTCs.
- Operate the system and verify the concern is still present.

Is the concern still present?

Yes	INSTALL a new HVAC module. REFER to Section 412-01 . TEST the system for normal operation.
No	The system is operating correctly at this time. The concern may have been caused by a loose or corroded connector. CLEAR the DTCs. REPEAT the self-test. TEST the system for normal operation.

Pinpoint Test S: Incorrect/Erratic Function in AUTO Mode

Refer to Wiring Diagrams Cell [55](#) , Automatic Climate Control System for schematic and connector information.

Normal Operation

Under normal operation, the in-vehicle air temperature sensor receives a ground and a 5-volt reference voltage from the HVAC module. To accurately monitor the cabin air temperature, the in-vehicle air temperature sensor uses an integral fan

to draw cabin air to the sensor, inside the instrument panel. The fan is supplied voltage and ground.

This pinpoint test is intended to diagnose the following:

- Wiring, terminals or connectors
- In-vehicle temperature sensor
- HVAC module

PINPOINT TEST S : INCORRECT/ERRATIC FUNCTION IN AUTO MODE

S1 CHECK IN-VEHICLE TEMPERATURE SENSOR FAN OPERATION

- Ignition ON.
- Make sure the ambient air temperature is above 2°C (35°F).
- Select PANEL mode.
- Press the A/C button (indicator ON).
- Press the RECIRC button (indicator ON).
- Place a piece of tissue within 25 mm (1 in) of the in-vehicle temperature/humidity sensor opening.

Is the tissue drawn to the sensor opening?

Yes	GO to S2 .
No	GO to S3 .

S2 CHECK THE SENSOR RESISTANCE

- Ignition OFF.
- Disconnect: In-Vehicle Temperature Sensor C233 .
- Measure the resistance between the in-vehicle temperature sensor C233 terminals and compare to the table below.

Ambient Temperature	Resistance
-40°C (-40°F)	869,073-1,061,986 ohms
-15°C (5°F)	196,465-231,213 ohms
0°C (32°F)	89,982-102,514 ohms
15°C (59°F)	44,261-49,503 ohms
25°C (77°F)	28,500-31,500 ohms
35°C (95°F)	18,563-20,751 ohms
60°C (140°F)	6,971-8,001 ohms
85°C (185°F)	2,959-3,474 ohms

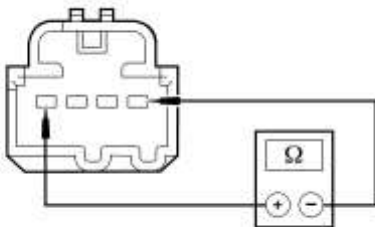

N0099182

Is the resistance within the specified values for the temperatures?

Yes	GO to S5 .
No	INSTALL a new in-vehicle temperature sensor. TEST the system for normal operation.

S3 CHECK CIRCUIT CBP30 (YE/BU) FOR VOLTAGE

- Ignition ON.
- Measure the voltage between in-vehicle temperature sensor [C233](#) Pin 3, circuit CBP30 (YE/BU), harness side and ground.

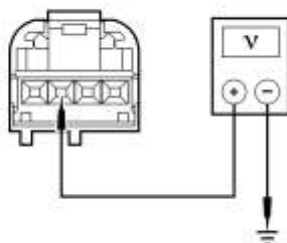

N0099244

Is the voltage greater than 10 volts?

Yes	GO to S4 .
No	VERIFY Smart Junction Box (SJB) fuse 30 (5A) is OK. If OK, REPAIR circuit CBP30 (YE/BU) for an open. TEST the system for normal operation. If not OK, REFER to the Wiring Diagrams manual to identify the possible causes of the circuit short.

S4 CHECK CIRCUIT GD114 (BK/BU) FOR GROUND

- Ignition OFF.
- Measure the resistance between in-vehicle temperature sensor [C233](#) Pin 2, circuit GD114 (BK/BU), harness side and ground.

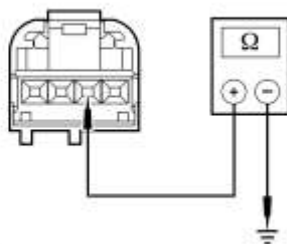

N0099245

Is the resistance less than 5 ohms?

Yes	INSTALL a new in-vehicle temperature sensor. TEST the system for normal operation.
No	REPAIR circuit GD114 (BK/BU) for an open. TEST the system for normal operation.

S5 CHECK THE HVAC MODULE CONNECTION

- Inspect the HVAC module connectors for:
 - corrosion.
 - pushed-out terminals.
 - damaged terminals.
- Connect and correctly seat all the HVAC module connectors.

- Clear the DTCs.
- Operate the system and verify the concern is still present.

Is the concern still present?

Yes	INSTALL a new HVAC module. REFER to Section 412-01 . TEST the system for normal operation.
No	The system is operating correctly at this time. The concern may have been caused by a loose or corroded connector. CLEAR the DTCs. REPEAT the self-test. TEST the system for normal operation.

Component Tests

Air Inlet Door Actuator

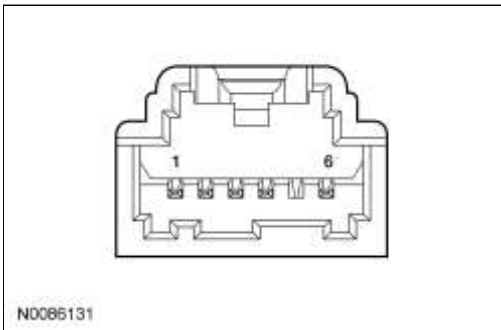

Actuator Pins	Approx. Resistance
1 and 6	65-80 ohms

Floor Mode Door Actuator

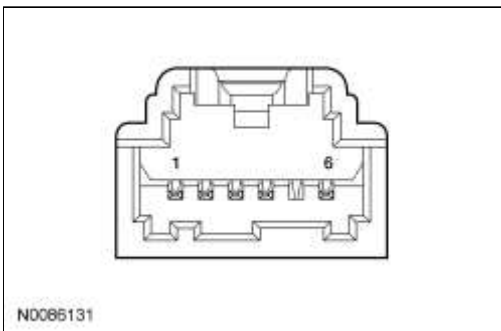

Actuator Pins	Approx. Resistance
5 and 6	80-97 ohms

Panel/Defrost Mode Door Actuator

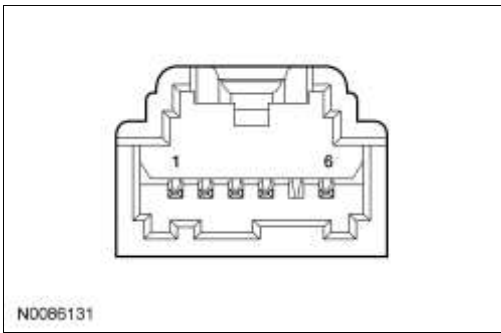

Actuator Pins	Approx. Resistance
2 and 3	2,775-4,625 ohms
2 and 4	188-4,313 ohms
3 and 4	188-4,313 ohms
1 and 6	71-86 ohms

Blend Mode Door Actuator

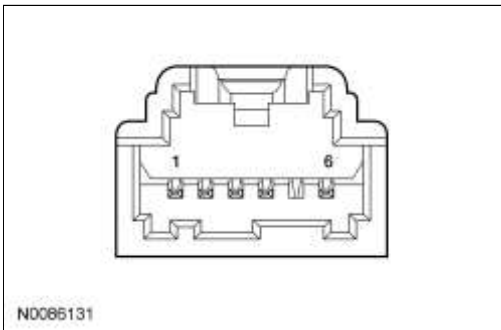

Actuator Pins	Approx. Resistance
2 and 3	2,775-4,625 ohms
2 and 4	188-4,313 ohms
3 and 4	188-4,313 ohms
1 and 6	40-50 ohms

Heater Core

- NOTE:** If a heater core leak is suspected, the heater core must be tested by carrying out the plugged heater core component test before the heater core pressure test. Carry out a system inspection by checking the heater system thoroughly as follows:

Inspect for evidence of coolant leakage at the heater water hose to heater core attachments. A coolant leak in the heater water hose could follow the heater core tube to the heater core and appear as a leak in the heater core.

- NOTE:** Spring-type clamps are installed as original equipment. Installation and overtightening of non-specification clamps can cause leakage at the heater water hose connection and damage the heater core.

Check the integrity of the heater water hose clamps.

Heater Core — Plugged

1. Check to see that the engine coolant is at the correct level.
2. Start the engine and turn on the heater.
3. When the engine coolant reaches operating temperature, check the heater core inlet and outlet hoses to see if they are hot.

If the inlet hose is not hot:

- the thermostat is not working correctly.

If the outlet hose is not hot:

- the heater core may have an air pocket.
- the heater core may be restricted or plugged.

Heater Core — Pressure Test

Use the Pressure Test Kit to carry out the pressure test.

1. **NOTE:** *Due to space limitations, a bench test may be necessary for pressure testing.*

Clamp off the heater hoses.

2.  **WARNING:** Before disconnecting any heater water hoses, shut OFF the engine and wait until engine is fully cool. Failure to comply with this warning may result in serious injury or burns from hot liquid escaping from the engine cooling system.

Disconnect the heater water hoses from the heater core.

3. Install a short piece of heater hose, approximately 101 mm (4 in) long on each heater core tube.
4. Fill the heater core and heater hoses with water and install plug BT-7422-B and the adapter BT-7422-A from the Pressure Test Kit. Secure the heater hoses, plug and adapter with hose clamps.

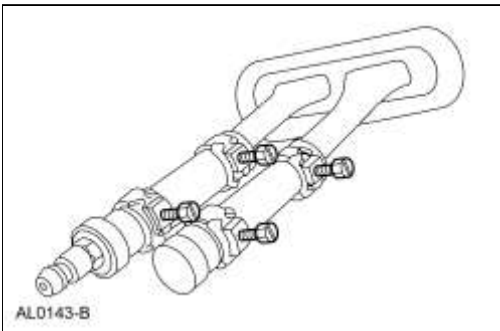

5. Attach the pump and gauge assembly from the Pressure Test Kit to the adapter.
6. Close the bleed valve at the base of the gauge. Pump 138 kPa (20 psi) of air pressure into the heater core.
7. Observe the pressure gauge for a minimum of 3 minutes.
8. If the pressure drops, check the heater water hose connections to the core tubes for leaks. If the heater water hoses do not leak, remove the heater core from the vehicle and carry out the bench test.

Heater Core — Bench Test

1. Remove the heater core from the vehicle. Refer to [Section 412-01](#).
2. Drain all of the coolant from the heater core.
3. Connect the 101 mm (4 in) test heater hoses with plug and adapter to the core tubes. Then connect the Pressure Test Kit to the adapter.
4. Apply 138 kPa (20 psi) of air pressure to the heater core. Submerge the heater core in water.

5. If a leak is observed, install a new heater core.

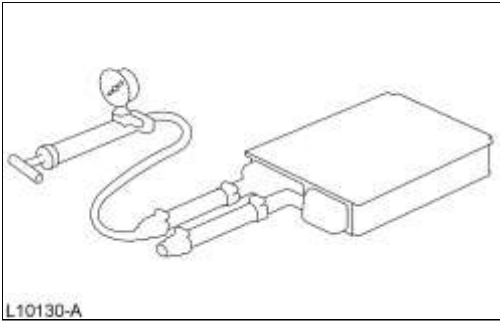

A/C Evaporator/Condenser Core — On Vehicle Leak Test

1. Recover the refrigerant. Refer to [Air Conditioning \(A/C\) System Recovery, Evacuation and Charging](#) in this section.
2. **NOTE:** *DO NOT* leak test an A/C evaporator core with the suction accumulator/drier attached to the core tubes.

Disconnect the suspect A/C evaporator core or A/C condenser core from the A/C system. Refer to [Section 412-01](#).

3. Connect the appropriate test fittings from the A/C Flush Adapter Kit to the evaporator or condenser tube connections.
4. **NOTE:** *The automatic shut-off valves on some gauge set hoses do not open when connected to the test fittings. If available, use hoses without shut-off valves. If hoses with shut-off valves are used, make sure the valve opens when attached to the test fittings or install an adapter which will activate the valve. The test is not valid if the shut-off valve does not open.*

Connect the red and blue hoses from the R-134a Manifold Gauge Set to the test fittings on the A/C evaporator core or A/C condenser core. Connect the yellow hose to a known good vacuum pump.

5. Open both gauge set valves and start the vacuum pump. Allow the vacuum pump to operate for a minimum of 45 minutes after the gauge set low pressure gauge indicates 101 kPa (30 in-Hg). The 45 minute evacuation is necessary to remove any refrigerant from oil left in the A/C evaporator core or A/C condenser core. If the refrigerant is not completely removed from the oil, outgassing will degrade the vacuum and appear as a refrigerant leak.
6. If the low pressure gauge reading will not drop to 101 kPa (30 in-Hg) when the valves on the gauge and manifold set are open and the vacuum pump is operating, close the gauge set valves and observe the low pressure gauge. If the pressure rises rapidly to zero, a large leak is indicated. Recheck the test fitting connections and gauge set connections before installing a new A/C evaporator core or A/C condenser core.
7. After evacuating for 45 minutes, close the gauge set valves and stop the vacuum pump. Observe the low pressure gauge; it should remain at the 101 kPa (30 in-Hg) mark.
 - If the low pressure gauge reading rises 34 or more kPa (10 or more in-Hg) of vacuum from the 101 kPa (30 in-Hg) position in 10 minutes, a leak is indicated.
 - If a very small leak is suspected, wait 30 minutes and observe the vacuum gauge.
 - If a small amount of vacuum is lost, operate the vacuum pump with gauge valves open for an additional 30 minutes to remove any remaining refrigerant from the oil in the A/C evaporator core or A/C condenser core. Then recheck for loss of vacuum.
 - If a very small leak is suspected, allow the system to set overnight with vacuum applied and check for vacuum loss.
8. If the A/C evaporator core or A/C condenser core does leak, as verified by the above procedure, install a new A/C evaporator core or A/C condenser core. Refer to [Section 412-01](#).

A/C Compressor — External Leak Test

1. Install the correct adapter from the A/C Flush Adapter Kit on the rear head of the A/C compressor, using the existing manifold retaining bolt.
2. Connect the high- and low-pressure lines of a manifold gauge set or a refrigerant recovery/recycling station to the corresponding fittings on the adapter.
3. Attach the center hose of the manifold gauge set to a refrigerant container standing in an upright position.

4. Open the low-pressure gauge valve, the high-pressure gauge valve and the valve on the refrigerant container to allow the refrigerant vapor to flow into the A/C compressor.
5. Using the Refrigerant Leak Detector, check for leaks at the compressor shaft.
6. If an external leak is found, install a new A/C compressor. Refer to [Section 412-01](#).
7. When the leak test is complete, recover the refrigerant from the compressor.