

ACCELERATOR
PEDAL POSITION SENSOR
151-16

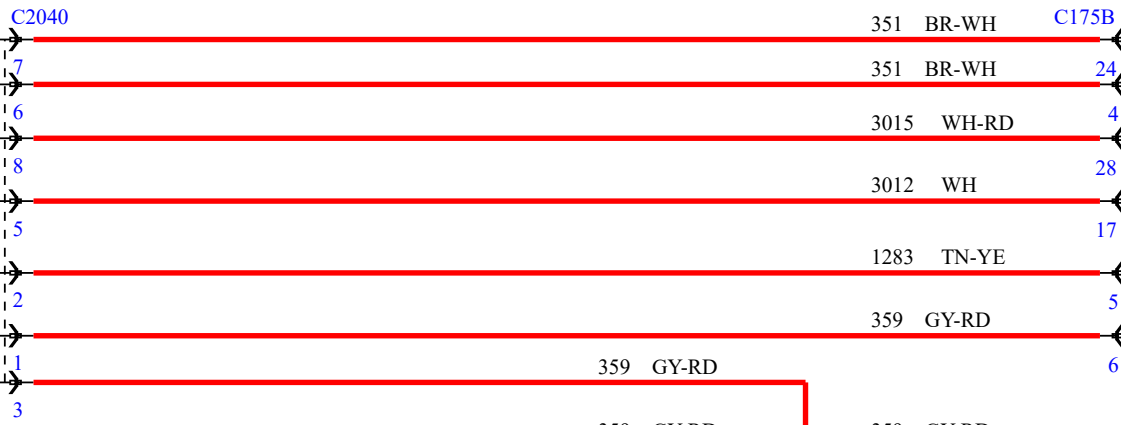

ELECTRONIC ENGINE CONTROLS

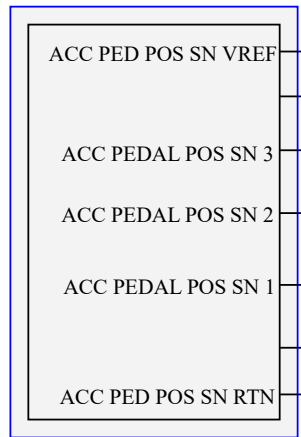
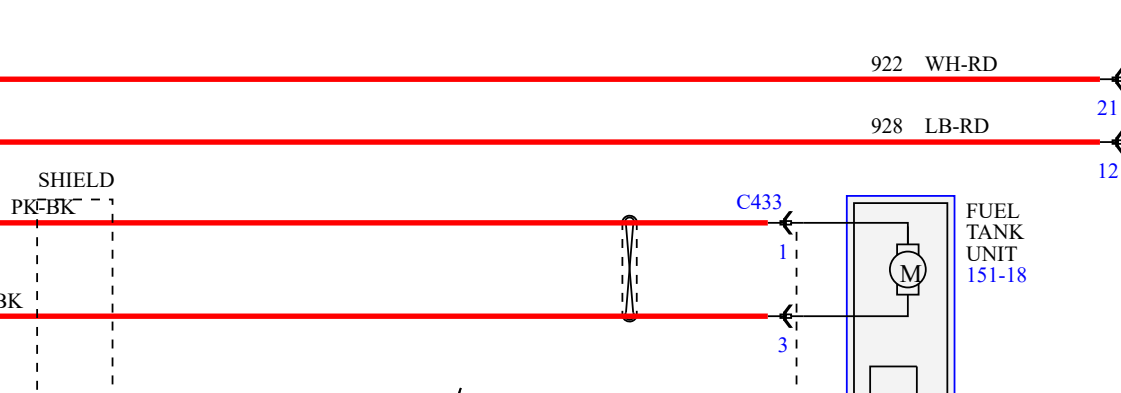
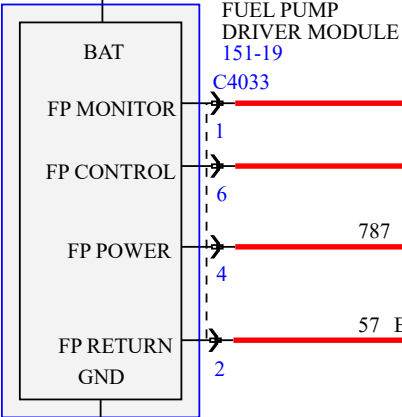
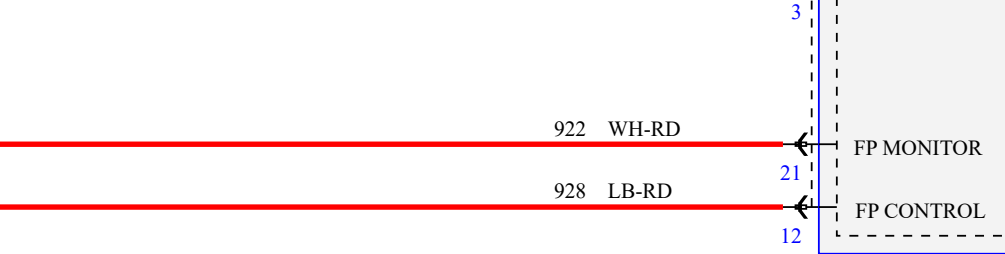
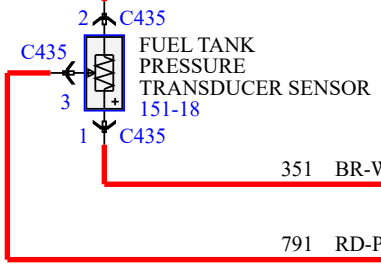
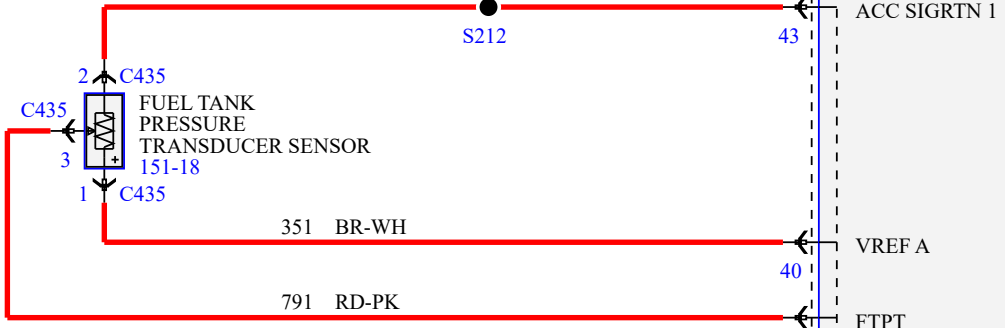
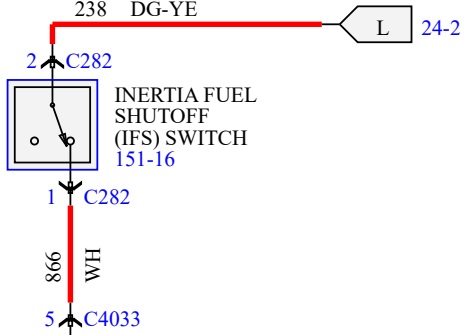

INSTRUMENT CLUSTER
60-3

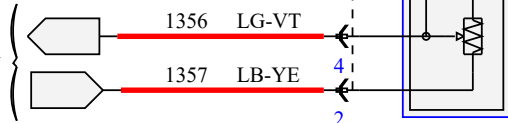

POWERTRAIN
CONTROL
MODULE (PCM)
151-6

