



Glass, Frames and Mechanisms

Refer to Wiring Diagrams Cell 56 for schematic and connector information.

Refer to Wiring Diagrams Cell 100 for schematic and connector information.

Special Tool(s)

 ST1137-A	73III Automotive Meter 105-R0057 or equivalent
 ST2332-A	Worldwide Diagnostic System (WDS) Vehicle Communication Module (VCM) with appropriate adapters, or equivalent scan tool

Principles of Operation

Power Window Control

NOTE: Battery voltage and ground must be removed before disconnecting the smart junction box (SJB) connectors to avoid setting false DTCs.

The power window one-touch up or down operations (front windows only) are controlled by the window motors. These features function only when the key is in the ON or ACC positions. The one-touch up or down operations are requested by pulling or pressing the window control switch up or down to the second detent. When the second detent of the window control switch is pulled/pressed, the auto circuit is grounded through the switch and the commanded up or down circuit is also grounded through the switch. Depending on which (up or down) circuit carries voltage, the window motor operates the window to the commanded one-touch up or down direction.

The window motor maintains operation until:

- the voltage at the window motor drops below 9 volts.
- a motor stall is detected by monitoring the current draw.

A momentary activation of the window control switch stops the one-touch up/down operation. Pulling or pressing the window control switches to the first detent operates the windows in a proportional mode. Each window motor has a dedicated auto circuit which provides ground to the window motor(s) for one-touch up/down operation.

Inspection and Verification

1. Verify the customer concern.
2. Visually inspect for obvious signs of mechanical or electrical damage.

Visual Inspection Chart

Mechanical	Electrical

Mechanical	Electrical
<ul style="list-style-type: none"> • Power window regulator • Window run weatherstrip • Door window glass 	<ul style="list-style-type: none"> • Bussed electrical center (BEC) fuses: <ul style="list-style-type: none"> ▪ 4 (30A) ▪ 6 (30A) ▪ 10 (30A) ▪ 11 (30A) ▪ 44 (10A) • Smart junction box (SJB) fuse 6 (5A) • SJB • Window control switch • Window motor • Heated rear window relay • Heated rear window switch • Heated rear window grid • Circuitry

3. If an obvious cause for an observed or reported concern is found, correct the cause (if possible) before proceeding to the next step.
4. If the cause is not visually evident, connect the scan tool to the data link connector (DLC), and select the vehicle to be tested from the scan tool menu. If the scan tool does not communicate with the vehicle:
 - check that the diagnostic card is correctly installed.
 - check the connections to the vehicle.
 - check the ignition switch position.
5. If the scan tool still does not communicate with the vehicle, refer to the scan tool operating manual.
6. Carry out the scan tool data link test. If the scan tool responds with:
 - CAN circuit fault; all electronic control units no response/not equipped, refer to [Section 418-00](#).
 - No response/not equipped for the SJB, refer to [Section 419-10](#).
 - System passed, retrieve and record the continuous diagnostic trouble codes (DTCs), erase the continuous DTCs, and carry out the self-test diagnostics for the SJB.
7. If the SJB DTCs retrieved are related to the concern, go to the Smart Junction Box (SJB) Diagnostic Trouble Code (DTC) Index.
8. If no DTCs related to the concern are retrieved, GO to [Symptom Chart](#).

Smart Junction Box (SJB) Diagnostic Trouble Code (DTC) Index

DTC	Description	Source	Action
B1342	ECU is Defective	SJB	CLEAR the DTCs. RETRIEVE the DTCs. If DTC B1342 is retrieved, INSTALL a new SJB. REFER to Section 419-10 . TEST the system for normal operation.
B1345	Heated Backlite Input Circuit Short to Ground	SJB	GO to Pinpoint Test D.
B1348	Heated Backlite Relay Circuit Open	SJB	GO to Pinpoint Test D.
B1349	Heated Backlite Relay Short to Battery	SJB	GO to Pinpoint Test D.
B1475	Accessory Delay Relay Short to Battery	SJB	GO to Pinpoint Test E.
B2052	Accessory Delay Relay Output Failure	SJB	GO to Pinpoint Test C.
B2060	Heated Backlite Indicator Circuit Failure	SJB	GO to Pinpoint Test D.
B2061	Heated Backlite Indicator Circuit Shorted to Ground	SJB	GO to Pinpoint Test E.

DTC	Description	Source	Action
B2360	Window Motor Control Output Circuit Failure	SJB	GO to Pinpoint Test F.
All other DTCs	—	SJB	REFER to Section 419-10.

Symptom Chart

Symptom Chart

Condition	Possible Sources	Action
<ul style="list-style-type: none"> No communication with the smart junction box (SJB) 	<ul style="list-style-type: none"> Circuitry SJB 	<ul style="list-style-type: none"> REFER to Section 419-10 to continue diagnosis of the communication network.
<ul style="list-style-type: none"> A single power window is inoperative/does not operate correctly — driver 	<ul style="list-style-type: none"> Circuitry Window control switch Ignition switch Window motor Smart junction box (SJB) Bussed electrical center (BEC) 	<ul style="list-style-type: none"> GO to Pinpoint Test A.
<ul style="list-style-type: none"> A single power window is inoperative/does not operate correctly — passenger 	<ul style="list-style-type: none"> Circuitry Passenger window control switch Driver window control switch Window motor Bussed electrical center (BEC) 	<ul style="list-style-type: none"> GO to Pinpoint Test B.
<ul style="list-style-type: none"> All power windows are inoperative 	<ul style="list-style-type: none"> Smart junction box (SJB) Bussed electrical center (BEC) 	<ul style="list-style-type: none"> INSTALL a new SJB. REFER to Section 419-10.
<ul style="list-style-type: none"> The rear power windows are inoperative 	<ul style="list-style-type: none"> Circuitry Rear window control switch Rear window motor(s) 	<ul style="list-style-type: none"> GO to Pinpoint Test C.

	<ul style="list-style-type: none"> Bussed electrical center (BEC) 	
<ul style="list-style-type: none"> The one-touch up/down feature is inoperative 	<ul style="list-style-type: none"> Circuitry Window control switch Ignition switch Window motor Smart junction box (SJB) 	<ul style="list-style-type: none"> If driver window, GO to Pinpoint Test A. If passenger window, GO to Pinpoint Test B.
<ul style="list-style-type: none"> The defrost system is inoperative 	<ul style="list-style-type: none"> Circuitry Heated rear window switch Heated rear window grid 	<ul style="list-style-type: none"> GO to Pinpoint Test D.
<ul style="list-style-type: none"> The defrost system will not shut off automatically 	<ul style="list-style-type: none"> Circuitry Heated rear window relay Heated rear window switch 	<ul style="list-style-type: none"> GO to Pinpoint Test E.
<ul style="list-style-type: none"> The global open/closing function is inoperative/does not operate correctly 	<ul style="list-style-type: none"> Circuitry Remote keyless entry (RKE) transmitters Smart junction box (SJB) 	<ul style="list-style-type: none"> GO to Pinpoint Test F.
<ul style="list-style-type: none"> The short drop windows do not operate correctly 	<ul style="list-style-type: none"> Circuitry Driver window motor Passenger window motor Door ajar switch Window motor not initialized 	<ul style="list-style-type: none"> GO to Pinpoint Test G.
<ul style="list-style-type: none"> Bounce-back occurring 	<ul style="list-style-type: none"> Door window glass out of adjustment Door window glass weatherstrip worn Obstruction in the window channel 	<ul style="list-style-type: none"> ADJUST the door window glass. INSTALL a new door window glass weatherstrip. REMOVE the obstruction from the window channel. DE-INITIALIZE the door window motor by disconnecting the battery with the door window motor in operation, then INITIALIZE the door window motor. REFER to Window Motor Initialization in this section.

<ul style="list-style-type: none"> The one-touch up feature is inoperative 	<ul style="list-style-type: none"> Door window motor not initialized Window control switch 	<ul style="list-style-type: none"> DE-INITIALIZE the door window motor by disconnecting the battery with the door window motor in operation, then INITIALIZE the door window motor. REFER to Window Motor Initialization in this section. If the one-touch up feature is still inoperative, INSTALL a new power window control switch.
<ul style="list-style-type: none"> The convertible top drop function is inoperative/does not operate correctly 	<ul style="list-style-type: none"> Global open/close function inoperative Window motor Circuitry Smart junction box (SJB) 	<ul style="list-style-type: none"> GO to Pinpoint Test H.

Connector Circuit Reference

Climate Control Assembly C294a

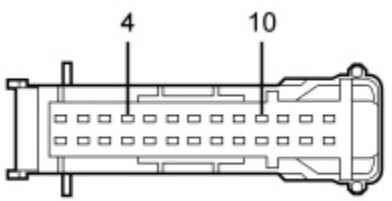

N0025902

Pin Number(s)	Circuit Designation/Description	Normal Condition/Measurement
4	1427 (TN/LB) voltage from the smart junction box (SJB) to climate control assembly heated rear window indicator	10 volts or greater with the key on and the heated rear window on.
10	1426 (PK) heated rear window switch signal to the SJB	Less than 5 ohms between the climate control assembly and the SJB. Greater than 10,000 ohms between the climate control assembly and ground.

Heated Rear Window C402 (Convertible)

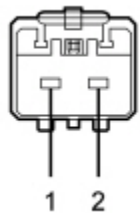

N0025534

Pin Number(s)	Circuit Designation/Description	Normal Condition/Measurement
1	186 (BN/LB) voltage supply to the heated rear window grid	Greater than 10 volts with the heated rear window on.

Pin Number(s)	Circuit Designation/Description	Normal Condition/Measurement
2	1205 (BK) heated rear window ground	Less than 5 ohms between the heated rear window connector and ground.

Heated Rear Window C402a (coupe)

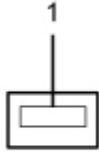

N0012425

Pin Number(s)	Circuit Designation/Description	Normal Condition/Measurement
1	186 (BN/LB) voltage supply to the heated rear window grid	Greater than 10 volts with the heated rear window on.

Heated Rear Window C402b (coupe)



N0012425

Pin Number(s)	Circuit Designation/Description	Normal Condition/Measurement
1	1205 (BK) heated rear window ground	Less than 5 ohms between the heated rear window and ground.

Driver Window Control Switch C504

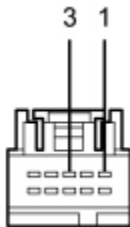

N0012603

Pin Number(s)	Circuit Designation/Description	Normal Condition/Measurement
1	1205 (BK) driver window control switch ground	Less than 5 ohms between the driver window control switch connector and ground.
3	985 (RD/LB) voltage to the driver window control switch	Greater than 10 volts with the key in the ON position.

Driver Window Motor C518, Passenger Window Motor C623

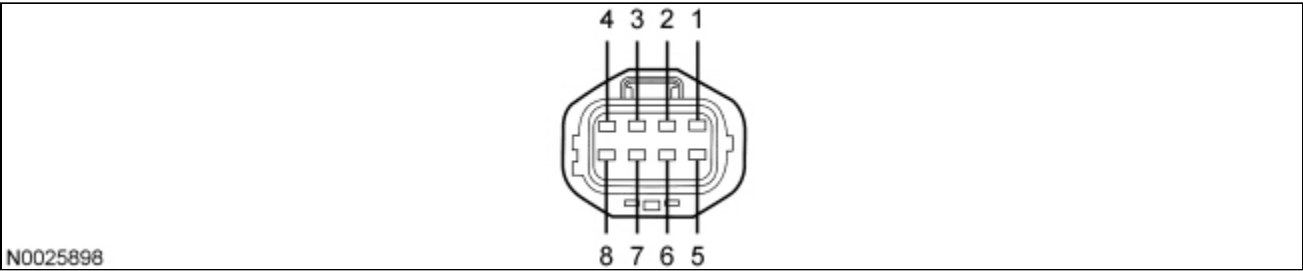

N0025898

Pin Number(s)	Circuit Designation/Description	Normal Condition/Measurement
1 (C518)	404 (VT/LG) auto (one-touch) signal to the driver window motor	Greater than 10 volts when the auto window function is commanded.
2 (C518)	400 (LB/BK) VPWR from the accessory delay relay	Greater than 10 volts with the key on, and for approximately 10 minutes after the key has been turned off.
3 (C518)	226 (WH/BK) up signal to the driver window motor	Greater than 10 volts with the driver window control switch in the up position.
4 (C518)	227 (YE) down signal to the driver window motor	10 volts with the driver window control switch in the down position.
5 (C518)	1312 (LG/BK) door ajar input	0 volts with the door closed, approximately 5 volts with the door open.
6 (C518)	2032 (LB) global open/close input	Less than 5 ohms resistance between the connectors (both connectors disconnected).
7 (C518)	2034 (VT/YE) B+ voltage to the driver window motor	Greater than 10 volts at all times.
8 (C518)	1205 (BK) driver window motor ground	Less than 5 ohms between the driver window motor connector and ground.
1 (C623)	405 (VT/LB) auto (one-touch) signal to the driver window motor	Greater than 10 volts when the auto window function is commanded.
2 (C623)	170 (RD/LB) VPWR from the accessory delay relay	Greater than 10 volts with the key on, and for approximately 10 minutes after the key has been turned off.
3 (C623)	313 (WH/YE) up signal to the driver window motor	Greater than 10 volts with the driver window control switch in the up position.
4 (C623)	314 (TN/LB) down signal to the driver window motor	10 volts with the driver window control switch in the down position.
5 (C623)	1314 (YE/LG) door ajar input	0 volts with the door closed, approximately 5 volts with the door open.
6 (C623)	2031 (GY/PK) global open/close input	Less than 5 ohms resistance between the connectors (both connectors disconnected).
7 (C623)	2033 (BN/LB) B+ voltage to the driver window motor	Greater than 10 volts at all times.
8 (C623)	1205 (BK) driver window motor ground	Less than 5 ohms between the driver window motor and ground.

Driver Door Ajar Switch C526, Passenger Door Ajar Switch C602



A0072424

Pin Number(s)	Circuit Designation/Description	Normal Condition/Measurement
1 (C526)	1205 (BK) driver door ajar switch ground	Less than 5 ohms to chassis ground.
2 (C526)	1312 (LG/BK) VREF from the SJB	Approximately 5 volts, greater than 10,000 ohms between the door ajar switch and ground.
1 (C602)	1205 (BK) passenger door ajar switch ground	Less than 5 ohms to chassis ground.
2 (C602)	1314 (YE/LG) VREF from the (SJB)	Approximately 5 volts, greater than 10,000 ohms between the door ajar switch and ground.

Rear Window Control Switch C566, Passenger Window Control Switch C604

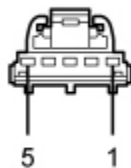

N0025899

Pin Number(s)	Circuit Designation/Description	Normal Condition/Measurement
1	1205 (BK) passenger window control switch ground	Less than 5 ohms between the passenger window control switch connector and ground.
5 (C566)	333 (YE/RD) rear window control switch voltage	Greater than 10 volts with the key on and for approximately 10 minutes after the key has been turned to off.
5 (C604)	984 (YE/LB) passenger window control switch voltage	Greater than 10 volts with the key on and for approximately 10 minutes after the key has been turned to off.

Heated Rear Window Relay C1099

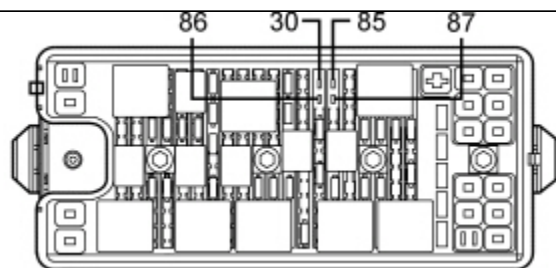

N0025848

Pin Number(s)	Circuit Designation/Description	Normal Condition/Measurement
30	298 (VT/OG) voltage supply to the heated rear window relay	Greater than 10 volts at all times.
85	298 (VT/OG) voltage supply to the heated rear window relay	Greater than 10 volts at all times.
86	1389 (WH) heated rear window relay solenoid ground	Less than 5 ohms between the heated rear window relay and ground with the heated rear window on.
87	186 (BN/LB) heated rear window voltage supply	0 volts, less than 5 ohms between the heated rear window relay and the rear window defrost grid.

Smart Junction Box (SJB) C2280b

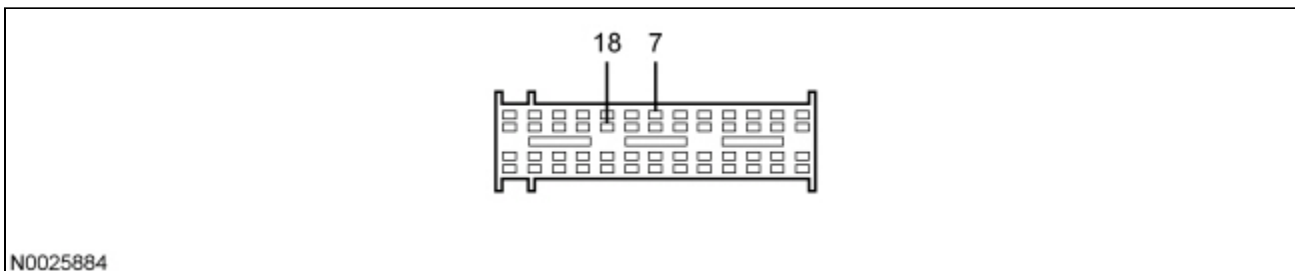

Pin Number(s)	Circuit Designation/Description	Normal Condition/Measurement
7	1427 (TN/LB) voltage from the SJB to the climate control assembly heated rear window indicator	Less than 5 ohms between the SJB and the climate control assembly. Greater than 10,000 ohms between the SJB and ground.
18	1426 (PK) heated rear window switch signal to the SJB from the climate control assembly	Less than 5 ohms between the SJB and the climate control assembly. Greater than 10,000 ohms between the SJB and ground.

Smart Junction Box (SJB) C2280c

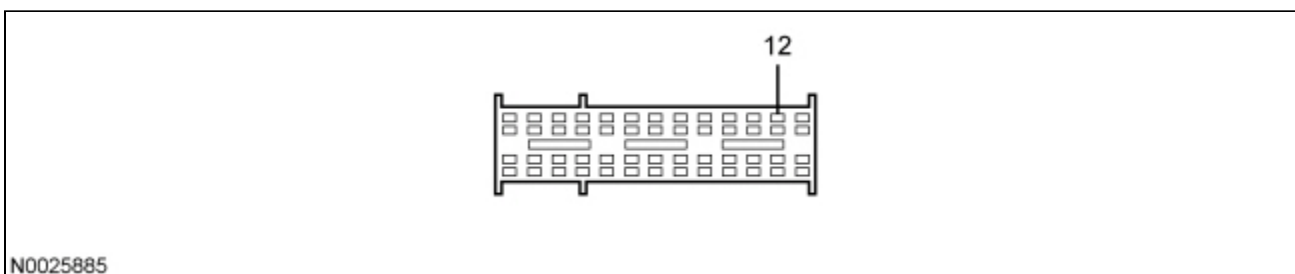

Pin Number(s)	Circuit Designation/Description	Normal Condition/Measurement
12	1389 (WH) heated rear window relay solenoid ground	Greater than 10 volts at all times. Less than 5 ohms between the SJB the heated rear window relay.

Smart Junction Box (SJB) C2280d

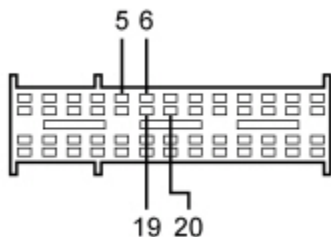

N0025617

Pin Number(s)	Circuit Designation/Description	Normal Condition/Measurement
5	2032 (LB) global open/close output to driver window motor	Less than 5 ohms resistance between the connectors (both connectors disconnected).
6	2031 (GY/PK) global open/close output to passenger window motor	Less than 5 ohms resistance between the connectors (both connectors disconnected).
19	2020 (GY/YE) convertible top drop output to LH rear window motor	Less than 5 ohms resistance between the connectors (both connectors disconnected).
20	2021 (WH/YE) convertible top drop output to RH rear window motor	Less than 5 ohms resistance between the connectors (both connectors disconnected).

Smart Junction Box (SJB) C2280e

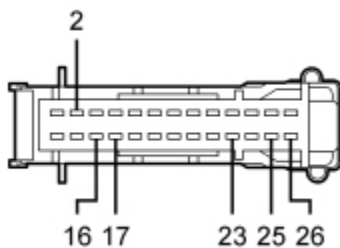

N0025602

Pin Number(s)	Circuit Designation/Description	Normal Condition/Measurement
2	1312 (LG/BK) VREF from the SJB	Approximately 5 volts, greater than 10,000 ohms between the door ajar switch and ground.
16	882 (BN/YE) delayed accessory voltage to RH rear window motor	Greater than 10 volts with the key on and for approximately 10 minutes after the key has been turned to off.
17	193 (YE/LG) delayed accessory voltage to LH rear window motor	Greater than 10 volts with the key on and for approximately 10 minutes after the key has been turned to off.
23	333 (YE/RD) rear window control switch voltage	Greater than 10 volts with the key on and for approximately 10 minutes after the key has been turned to off.
25	984 (YE/LB) passenger window control switch voltage	Greater than 10 volts with the key on and for approximately 10 minutes after the key has been turned to off.
26	985 (RD/LB) driver window control switch voltage	Greater than 10 volts with the key on and for approximately 10 minutes after the key has been turned to off.

LH Rear Passenger Window Motor C3118, RH Rear Passenger Window Motor C3119

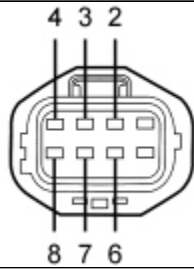

N0025900

Pin Number(s)	Circuit Designation/Description	Normal Condition/Measurement
2	882 (BN/YE) accessory delay voltage to rear window motors	Greater than 10 volts with the key in the on position.
3	884 (YE/BK) up signal to the passenger window motor	Greater than 10 volts when the passenger window control switch is in the up position.
4	885 (YE/LB) down signal to the passenger window motor	Greater than 10 volts when the passenger window control switch is in the down position.
6	2031 (GY/PK) convertible top drop input to the rear window motor(s)	Less than 5 ohms resistance between the connectors (both connectors disconnected).
7	1670 (BN/YE) B+ voltage to the passenger window motor	Greater than 10 volts at all times.
8	1205 (BK) passenger window motor ground	Less than 5 ohms between the passenger window motor and ground.

Pinpoint Test A: A Single Power Window is Inoperative/Does Not Operate Correctly — Driver

Normal Operation

With the key in the ON position (or with the delayed accessory function active), pulling the window control switch up provides voltage on circuit 226 (WH/BK) to the window motor. Pressing the window control switch down provides voltage on circuit 227 (YE) to the window motor. Depending on which circuit has voltage supplied determines which direction the window motor operates. The window motor operates in the commanded direction to move the window up or down.

Possible Causes

- Circuit 226 (WH/BK) open
- Circuit 227 (YE) open
- Circuit 404 (VT/LG) open
- Circuit 1205 (BK) open
- Circuit 2034 (VT/YE) open
- Ignition switch
- Window motor
- Window control switch
- Smart junction box (SJB)

PINPOINT TEST A : A SINGLE POWER WINDOW IS INOPERATIVE/DOES NOT OPERATE CORRECTLY— DRIVER

A1 CHECK THE POWER SUPPLY TO THE DRIVER WINDOW CONTROL SWITCH
<ul style="list-style-type: none"> • Ignition OFF. • Disconnect: Driver Window Control Switch C504. • Ignition ON. • Measure the voltage between the driver window control switch C504 Pin 3, circuit 985 (RD/LB), harness side and ground.

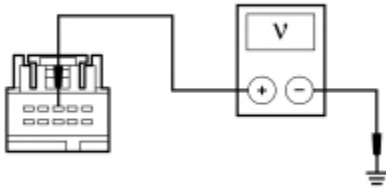

N0012607

Is the voltage greater than 10 volts?

Yes	GO to A2 .
No	GO to A11 .

A2 CHECK CIRCUIT 1205 (BK) FOR AN OPEN

- Ignition OFF.
- Measure the resistance between the driver window control switch C504 Pin 1, circuit 1205 (BK), harness side and ground.

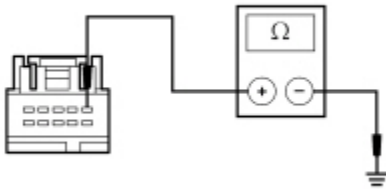

N0012608

Is the resistance less than 5 ohms?

Yes	GO to A3 .
No	REPAIR the circuit. TEST the system for normal operation.

A3 CHECK THE DRIVER WINDOW CONTROL SWITCH

- Carry out the window control switch component test.
Refer to Wiring Diagrams Cell 149 for component testing.

Is the driver window control switch ok?

Yes	GO to A4 .
No	INSTALL a new driver window control switch. REFER to Window Control Switch in this section. TEST the system for normal operation.

A4 CHECK FOR SHORT BETWEEN CIRCUITS 226 (WH/BK) AND 227 (YE)

- Disconnect: Driver Window Motor C518.
- Measure the resistance between driver window motor C518 Pin 3, circuit 226 (WH/BK), harness side and C518 Pin 4, circuit 227 (YE), harness side.

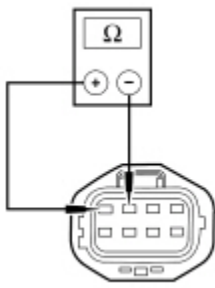

N0093721

Is the resistance greater than 10,000 ohms?

Yes	GO to A5 .
No	REPAIR the circuit. TEST the system for normal operation.

A5 CHECK CIRCUIT 227 (YE) FOR AN OPEN

- Connect: Driver Window Control Switch C504.
- Ignition ON.
- Measure the voltage between the driver window motor C518 Pin 4, circuit 227 (YE), harness side and ground while rocking the driver window control switch to the DOWN position.

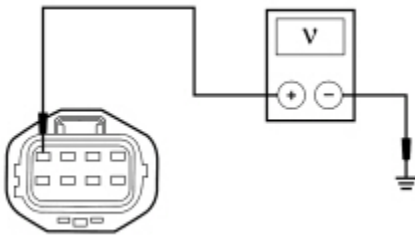

N0012609

Is the voltage greater than 10 volts with the switch in the DOWN position?

Yes	GO to A6 .
No	REPAIR the circuit. TEST the system for normal operation.

A6 CHECK CIRCUIT 226 (WH/BK) FOR AN OPEN

- Measure the voltage between the driver window motor C518 Pin 3, circuit 226 (WH/BK), harness side and ground while rocking the driver window control switch to the UP position.

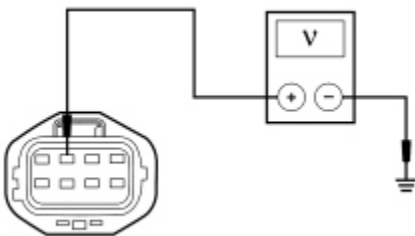

N0012610

Is the voltage greater than 10 volts with the switch in the UP position?

Yes	GO to A7 .
No	REPAIR the circuit. TEST the system for normal operation.

A7 CHECK CIRCUIT 404 (VT/LG) FOR AN OPEN

- Measure the resistance between the driver window motor C518 Pin 1, circuit 404 (VT/LG), harness side and ground while rocking the driver window control switch to the UP and DOWN positions.

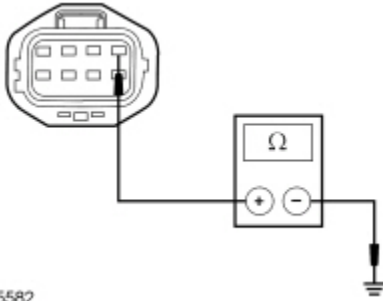

Is the resistance less than 5 ohms with the switch in the UP and DOWN positions?

Yes	GO to A8 .
No	REPAIR the circuit. TEST the system for normal operation.

A8 CHECK CIRCUIT 2034 (VT/YE) FOR AN OPEN

- Measure the voltage between the driver window motor C518 Pin 7, circuit 2034 (VT/YE), harness side and ground.

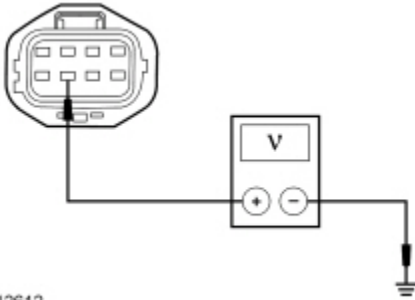

Is the voltage greater than 10 volts?

Yes	GO to A9 .
No	REPAIR the circuit. TEST the system for normal operation.

A9 CHECK CIRCUIT 400 (LB/BK) FOR AN OPEN

- Measure the voltage between the driver window motor C518 Pin 2, circuit 400 (LB/BK), harness side and ground.

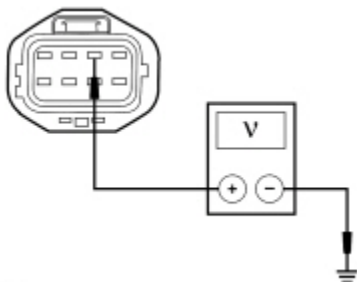

Is the voltage greater than 10 volts?

Yes	GO to A10 .
------------	-----------------------------

No REPAIR the circuit. TEST the system for normal operation.

A10 CHECK CIRCUIT 1205 (BK) FOR AN OPEN

- Measure the resistance between the driver window motor C518 Pin 8, circuit 1205 (BK), harness side and ground.

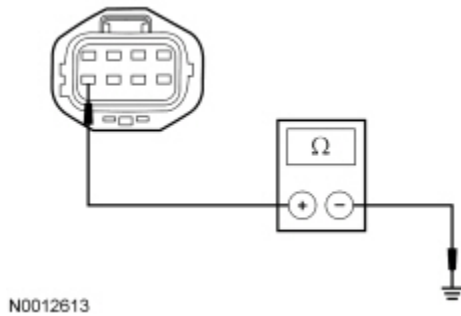

Is the resistance less than 5 ohms?

Yes	INSTALL a new driver window motor. REFER to Window Regulator and Motor — Front Door in this section. TEST the system for normal operation.
No	REPAIR the circuit. TEST the system for normal operation.

A11 CHECK CIRCUIT 985 (RD/LB) FOR AN OPEN

- Ignition OFF.
- Disconnect: Smart Junction Box (SJB) C2280e.
- Measure the resistance between the driver window control switch C504 Pin 3, circuit 985 (RD/LB), harness side and the SJB C2280E Pin 26, circuit 985 (RD/LB), harness side.

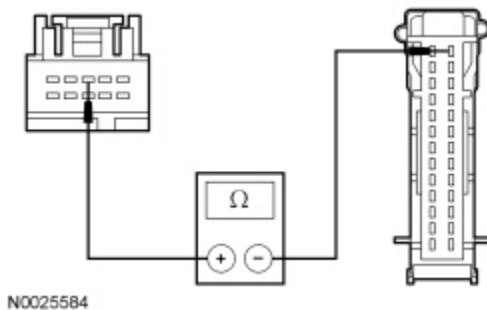

Is the resistance less than 5 ohms?

Yes	GO to A12 .
No	REPAIR the circuit. TEST the system for normal operation.

A12 CHECK THE SJB FOR CORRECT OPERATION

- Disconnect all of the SJB connectors.
- Check for:
 - corrosion
 - pushed-out pins
- Connect all of the SJB connectors and make sure they seat correctly.
- Operate the system and verify the concern is still present.

Is the concern still present?

Yes	INSTALL a new SJB. REFER to Section 419-10 . REPEAT the self-test. TEST the system for normal operation.
------------	--

No	The system is operating correctly at this time. The concern may have been caused by a loose or corroded connector. CLEAR the DTCs. REPEAT the self-test. TEST the system for normal operation.
-----------	--

Pinpoint Test B: A Single Power Window is Inoperative/Does Not Operate Correctly— Passenger

Refer to Wiring Diagrams Cell 100, Power Windows for schematic and connector information.

Normal Operation

During normal operation, battery voltage is provided to the passenger power window motor at all times through circuit 2033 (BN/LB). When the accessory delay relay is active, the passenger power window motor receives voltage through circuit 170 (RD/LB) and the passenger front window control switch receives voltage through circuit 984 (YE/LB). Ground is provided to the passenger power window motor through circuit 1205 (BK). Pulling the driver or passenger window control switch up provides voltage to the window motor through circuit 313 (WH/YE) to command the window up. Pressing the driver or passenger window control switch down provides voltage to the window motor through circuit 314 (TN/LB) to command the window down.

This pinpoint test is intended to diagnose the following:

- Fuse(s)
- Wiring, terminals or connectors
- Driver window control switch
- Front passenger window control switch
- Front passenger window motor

PINPOINT TEST B : A SINGLE POWER WINDOW IS INOPERATIVE — PASSENGER FRONT

NOTICE: Use the correct probe adapter(s) when making measurements. Failure to use the correct probe adapter(s) may damage the connector.

B1 CHECK THE OPERATION FROM THE DRIVER WINDOW CONTROL SWITCH

- Using the driver window switch, operate the passenger window in the up, down and auto positions.

Does the passenger window operate for all positions?

Yes	GO to B12 .
No	GO to B2 .

B2 CHECK THE DRIVER WINDOW CONTROL SWITCH

- Ignition OFF.
- Disconnect: Driver Window Control Switch C504.
- Carry out the Master Window Adjust Switch component test. Refer to Wiring Diagrams Cell 149 for component testing.

Did the driver window control switch pass the component test?

Yes	GO to B3 .
No	INSTALL a new driver window control switch. REFER to Window Control Switch in this section. TEST the system for normal operation.

B3 CHECK CIRCUIT 2033 (BN/LB) FOR VOLTAGE

- Disconnect: Front Passenger Window Motor C623.
- Ignition ON.
- Measure the voltage between front passenger window motor C623 Pin 7, circuit 2033 (BN/LB), harness side and ground.

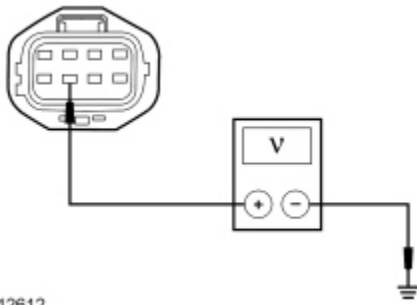

N0012612

Is the voltage greater than 10 volts?

Yes	GO to B4 .
No	VERIFY that bussed electrical center (BEC) fuse 7 (30A) is OK. If OK, REPAIR the circuit. If not OK, REFER to the Wiring Diagrams Manual to identify the possible causes of the circuit short. TEST the system for normal operation.

B4 CHECK CIRCUIT 170 (RD/LB) FOR VOLTAGE

- Measure the voltage between front passenger window motor C623 Pin 2, circuit 170 (RD/LB), harness side and ground.

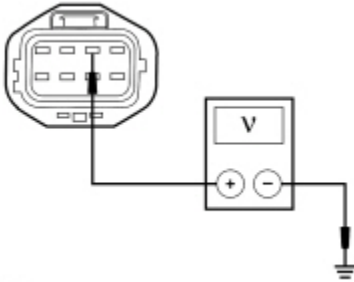

N0025583

Is the voltage greater than 10 volts?

Yes	GO to B5 .
No	VERIFY that smart junction box (SJB) fuse 6 (5A) is OK. If OK, REPAIR the circuit. If not OK, REFER to the Wiring Diagrams Manual to identify the possible causes of the circuit short. TEST the system for normal operation.

B5 CHECK CIRCUIT 1205 (BK) FOR AN OPEN

- Ignition OFF.
- Measure the resistance between front passenger window motor C623 Pin 8, circuit 1205 (BK), harness side and ground.

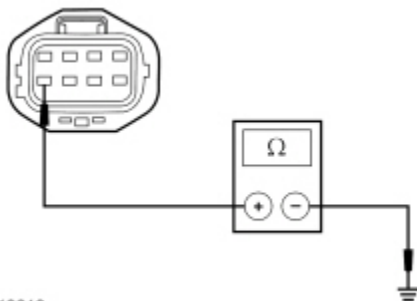

N0012613

Is the resistance less than 5 ohms?

Yes	GO to B6 .
No	REPAIR the circuit. TEST the system for normal operation.

B6 CHECK CIRCUITS 313 (WH/YE) AND 314 (TN/LB) FOR A SHORT TO VOLTAGE

- Ignition ON.
- Measure the voltage between ground and front passenger window motor:
 - C623 Pin 3, circuit 313 (WH/YE), harness side.
 - C623 Pin 4, circuit 314 (TN/LB), harness side.

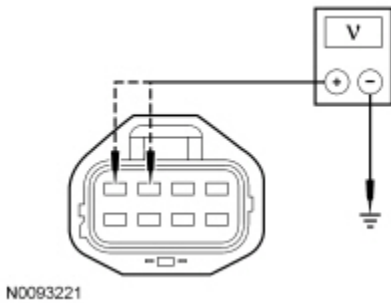

Is any voltage present?

Yes	GO to B7 .
No	GO to B8 .

B7 CHECK FOR A SHORTED FRONT PASSENGER WINDOW CONTROL SWITCH

- Ignition OFF.
- Disconnect: Front Passenger Window Control Switch C604.
- Ignition ON.
- Measure the voltage between ground and front passenger window motor:
 - C623 Pin 3, circuit 313 (WH/YE), harness side.
 - C623 Pin 4, circuit 314 (TN/LB), harness side.

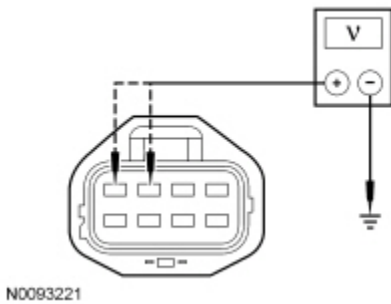

Is any voltage present?

Yes	REPAIR the circuit(s). TEST the system for normal operation.
No	INSTALL a new front passenger window control switch. REFER to Window Control Switch in this section. TEST the system for normal operation.

B8 CHECK CIRCUIT 405 (VT/LB) FOR A SHORT TO GROUND

- Ignition OFF.
- Measure the resistance between front passenger window motor C623 Pin 1, circuit 405 (VT/LB), harness side and ground.

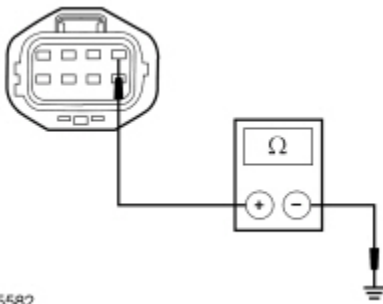

N0025582

Is the resistance greater than 10,000 ohms?

Yes	GO to B10 .
No	GO to B9 .

B9 CHECK FOR A SHORTED FRONT PASSENGER WINDOW CONTROL SWITCH

- Disconnect: Front Passenger Window Control Switch C604.
- Measure the resistance between front passenger window motor C623 Pin 1, circuit 405 (VT/LB), harness side and ground.

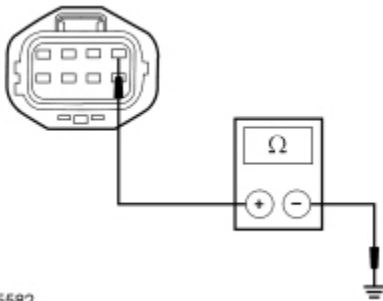

N0025582

Is the resistance greater than 10,000 ohms?

Yes	REPAIR the circuit(s). TEST the system for normal operation.
No	INSTALL a new front passenger window control switch. REFER to Window Control Switch in this section. TEST the system for normal operation.

B10 CHECK FOR SHORT BETWEEN CIRCUITS 313 (WH/YE) AND 314 (TN/LB)

- Disconnect: Front Passenger Window Control Switch C604.
- Measure the resistance between front passenger window motor C623 Pin 3, circuit 313 (WH/YE), harness side and C623 Pin 4, circuit 314 (TN/LB), harness side.

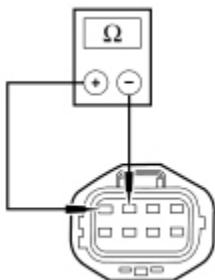

N0093721

Is the resistance greater than 10,000 ohms?

Yes	GO to B11 .
No	REPAIR the circuit. TEST the system for normal operation.

B11 CHECK CIRCUITS 313 (WH/YE), 314 (TN/LB) AND 405 (VT/LB) FOR AN OPEN

- Measure the resistance between driver window control switch C504, harness side and front passenger window motor C623, harness side using the following chart:

Driver Window Control Switch	Circuit	Front Passenger Window Motor
C504 Pin 4	314 (TN/LB)	C623 Pin 4
C504 Pin 9	405 (VT/LB)	C623 Pin 1
C504 Pin 10	313 (WH/YE)	C623 Pin 3

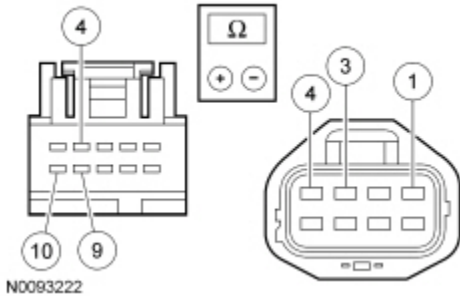

Are the resistances less than 5 ohms?

Yes	INSTALL a new front passenger window motor. REFER to Window Regulator and Motor — Front Door in this section. TEST the system for normal operation.
No	REPAIR the circuit(s). TEST the system for normal operation.

B12 CHECK THE FRONT PASSENGER WINDOW CONTROL SWITCH

- Ignition OFF.
- Carry out the Window Adjust Switch, Passenger Side component test. Refer to Wiring Diagrams Cell 149 for component testing.

Did the front passenger window control switch pass the component test?

Yes	GO to B13 .
No	INSTALL a new front passenger window control switch. REFER to Window Control Switch in this section. TEST the system for normal operation.

B13 CHECK CIRCUIT 984 (YE/LB) FOR VOLTAGE

- Measure the voltage between front passenger window control switch C604 Pin 5, circuit 984 (YE/LB), harness side and ground.

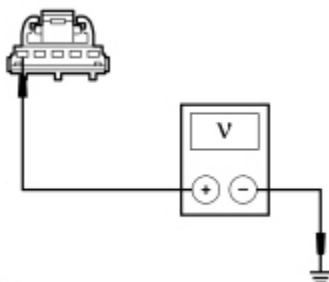

Is the voltage greater than 10 volts?

Yes	GO to B14 .
No	VERIFY that SJB fuse 6 (5A) is OK. If OK, REPAIR the circuit. If not OK, REFER to the Wiring Diagrams Manual to identify the possible causes of the circuit short. TEST the system for normal operation.

B14 CHECK CIRCUITS 313 (WH/YE), 314 (TN/LB) AND 405 (VT/LB) FOR AN OPEN

- Measure the resistance between front passenger window control switch C604, harness side and front passenger window motor C623, harness side using the following chart:

Front Passenger Window Control Switch	Circuit	Front Passenger Window Motor
C604 Pin 2	405 (VT/LB)	C623 Pin 1
C604 Pin 4	313 (WH/YE)	C623 Pin 3
C604 Pin 3	314 (TN/LB)	C623 Pin 4

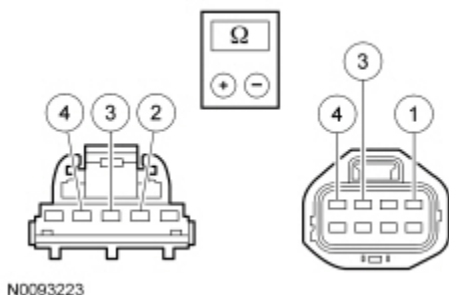

Are the resistances less than 5 ohms?

Yes	INSTALL a new front passenger window motor. REFER to Window Regulator and Motor — Front Door in this section. TEST the system for normal operation.
No	REPAIR the circuit(s). TEST the system for normal operation.

Pinpoint Test C: The Rear Power Windows are Inoperative

Normal Operation

With the key in the ON position (or with the delayed accessory function active), pulling the window control switch up or pressing the switch down supplies voltage to the window motor. Depending on which circuit has voltage supplied determines which direction the window motor operates. The window motor operates in the commanded direction to move the window up or down.

Possible Causes

- Circuit 333 (YE/RD) open
- Circuit 193 (YE/LG) open
- Circuit 882 (BN/YE) open
- Circuit 884 (YE/BK) open
- Circuit 885 (YE/LB) open
- Circuit 1670 (BN/YE) open
- Circuit 1773 (RD/LB) open
- Circuit 1205 (BK) open
- Rear window control switch
- Window motor

PINPOINT TEST C : THE REAR POWER WINDOWS ARE INOPERATIVE

C1 CHECK THE OPERATION OF THE REAR WINDOWS

- Operate the rear windows with the driver rear window control switch.

Are both rear windows inoperative?

Yes	GO to C2 .
No	GO to C5 .

C2 CHECK THE REAR WINDOW CONTROL SWITCH

- Ignition OFF.
- Disconnect: Rear Window Control Switch C566.
- Carry out the window control switch component test.
Refer to Wiring Diagrams Cell 149 for component testing.

Is the window control switch ok?

Yes	GO to C3 .
No	INSTALL a new window control switch. REFER to Window Control Switch in this section. TEST the system for normal operation.

C3 CHECK CIRCUIT 333 (YE/RD) FOR VOLTAGE

- Ignition ON.
- Measure the voltage between the rear window control switch C566 Pin 5 circuit 333 (YE/RD), harness side and ground.

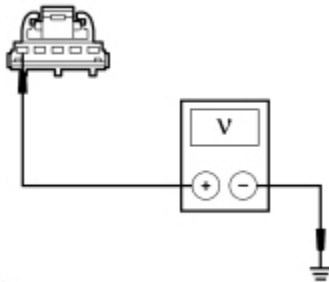

N0025586

Is the voltage greater than 10 volts?

Yes	GO to C5 .
No	GO to C4 .

C4 CHECK CIRCUIT 333 (YE/RD) FOR AN OPEN

- Ignition OFF.
- Disconnect: Smart Junction Box (SJB) C2280e.
- Measure the resistance between the rear window control switch C566 Pin 5 circuit 333 (YE/RD), harness side and the SJB C2280E Pin 23 circuit 333 (YE/RD), harness side.

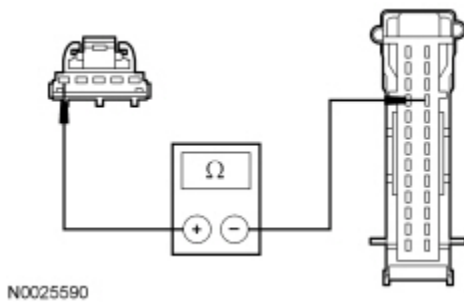

Is the resistance less than 5 ohms?

Yes	GO to C12 .
No	REPAIR the circuit. TEST the system for normal operation.

C5 CHECK CIRCUIT 1205 (BK) FOR AN OPEN

- Ignition OFF.
- Disconnect: Suspect Window Motor C3118 (Left Rear) or C3119 (Right Rear).
- Measure the resistance between the LH rear window motor C3118 Pin 8, or the RH rear window motor C3119 Pin 8, circuit 1205 (BK), harness side and ground.

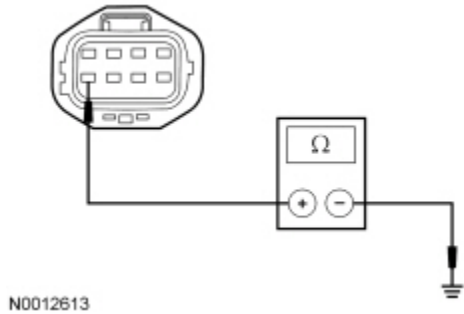

Is the resistance less than 5 ohms?

Yes	GO to C6 .
No	REPAIR the circuit. TEST the system for normal operation.

C6 CHECK THE VBATT CIRCUIT FOR AN OPEN

- Ignition ON.
- Measure the voltage between the LH rear window motor, C3118 Pin 7, or the RH rear window motor C3119 Pin 7, circuit 1670 (BN/YE), harness side and ground.

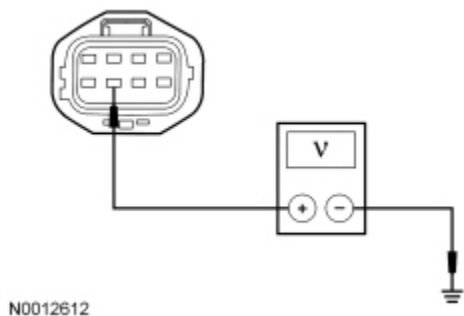

Is the voltage greater than 10 volts?

Yes	GO to C7 .
No	REPAIR the circuit. TEST the system for normal operation.

C7 CHECK CIRCUIT 885 (YE/LB) FOR AN OPEN

- Ignition OFF.
- Connect: Rear Window Control Switch C566.
- Ignition ON.
- While rocking the rear window control switch to the down position, measure the voltage between the LH rear window motor C3118 Pin 4, or C3119 Pin 4, circuit 885 (YE/LB), harness side and ground.

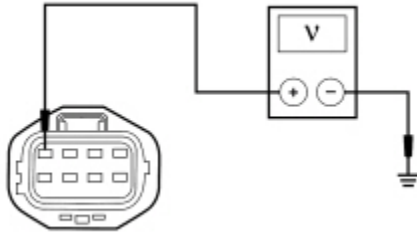

N0012609

Is the voltage greater than 10 volts with the switch in the DOWN position?

Yes	GO to C8 .
No	REPAIR the circuit. TEST the system for normal operation.

C8 CHECK CIRCUIT 884 (YE/BK) FOR AN OPEN

- While rocking the passenger window control switch to the UP position, measure the voltage between the LH rear window motor C3118 Pin 3, or C3119 Pin 3, circuit 884 (YE/BK), harness side and ground .

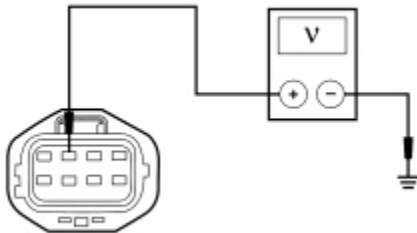

N0012610

Is the voltage greater than 10 volts with the switch in the UP position?

Yes	GO to C9 .
No	REPAIR the circuit. TEST the system for normal operation.

C9 CHECK FOR SHORT BETWEEN CIRCUITS 884 (YE/BK) AND 885 (YE/LB)

- Ignition OFF.
- Disconnect: Rear Window Control Switch C566.
- Measure the resistance between LH rear window motor C3118 Pin 3, circuit 884 (YE/BK), harness side and C3118 Pin 4, circuit 885 (YE/LB), harness side.

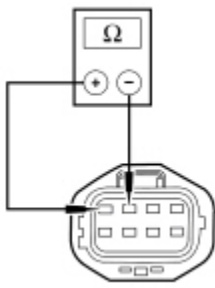

N0093721

Is the resistance greater than 10,000 ohms?

Yes	GO to C10 .
No	REPAIR the circuit. TEST the system for normal operation.

C10 CHECK CIRCUIT 882 (BN/YE) FOR VOLTAGE

- Ignition ON.
- Measure the voltage between the LH rear window motor C3118 Pin 2, or RH rear window motor C3119 Pin 2, circuit 882 (BN/YE), harness side and ground.

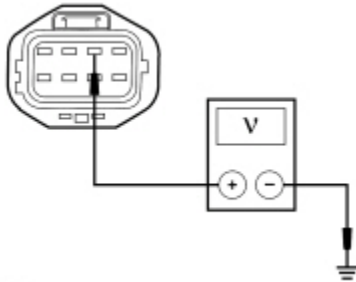

N0025583

Is the voltage greater than 10 volts?

Yes	INSTALL a new rear quarter window regulator and motor. REFER to Window Regulator Motor — Rear Quarter in this section. TEST the system for normal operation.
No	GO to C11 .

C11 CHECK CIRCUITS 882 (BN/YE) OR 193 (YE/LG) FOR AN OPEN

- Ignition OFF.
- Disconnect: SJB C2280e.
- Measure the resistance between the LH rear window motor C3118 Pin 2 circuit 882 (BN/YE), harness side and the SJB C2280E Pin 17 circuit 193 (YE/LG), harness side; or between the RH rear window motor C3119 Pin 2 circuit 882 (BN/YE), harness side and the SJB C2280E Pin 16 circuit 882 (BN/YE), harness side

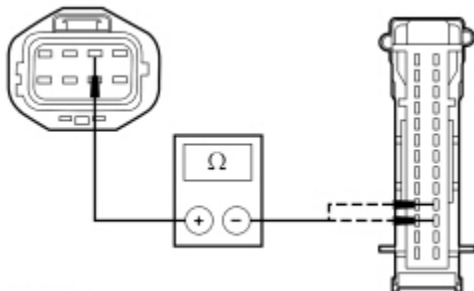

N0025608

Is the resistance less than 5 ohms?

--	--

Yes	GO to C12 .
No	REPAIR the circuit in question. TEST the system for normal operation.

C12 CHECK THE SJB FOR CORRECT OPERATION

- Disconnect all of the SJB connectors.
- Check for:
 - corrosion
 - pushed-out pins
- Connect all of the SJB connectors and make sure they seat correctly.
- Operate the system and verify the concern is still present.

Is the concern still present?

Yes	INSTALL a new SJB. REFER to Section 419-10 . TEST the system for normal operation.
No	The system is operating correctly at this time. The concern may have been caused by a loose or corroded connector. CLEAR the DTCs. REPEAT the self-test. TEST the system for normal operation.

Pinpoint Test D: The Defrost System is Inoperative

Normal Operation

When the rear defrost switch on the climate control assembly is pressed, a ground signal is sent to the smart junction box (SJB) on circuit 1426 (PK). The SJB then grounds circuit 1389 (WH). This energizes the heated rear window relay, allowing voltage to be supplied to the heated rear window grid through circuit 186 (BN/LB). The heated rear window grid is grounded by circuit 1205 (BK).

Possible Causes

- Circuit 186 (BN/LB) open
- Circuit 1205 (BK) open
- Circuit 1389 (WH) open
- Circuit 1426 (PK) open
- Heated rear window relay
- Heated rear window switch
- Heated rear window grid

PINPOINT TEST D : THE DEFROST SYSTEM IS INOPERATIVE

D1 CHECK FOR RECORDED SMART JUNCTION BOX (SJB) DTCS

- Ignition ON.
- Use the recorded results from the SJB self-test.

Are any DTCs retrieved?

Yes	If DTC B1348 or B1349, GO to D9 . If DTC B1345, GO to D13 . If DTC B2060 or B2061, GO to D15 .
No	GO to D2 .

D2 CHECK CIRCUIT 1389 (WH) FOR GROUND

- Ignition OFF.
- Disconnect: Heated Rear Window Relay.
- Ignition ON.
- Press the heated rear window switch to ON.
- Measure the resistance between the heated rear window relay C1099 Pin 86, circuit 1389 (WH), harness side and ground.

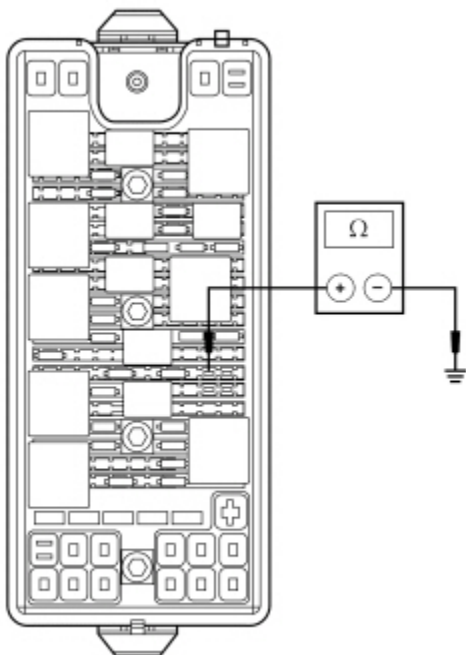

N0025842

Is the resistance less than 100 ohms?

Yes	GO to D3 .
No	GO to D7 .

D3 CHECK CIRCUIT 298 (VT/OG) FOR AN OPEN

- Ignition OFF.
- Measure the voltage between the heated rear window relay C1099 Pin 30 and C1099 Pin 85, circuit 298 (VT/OG), harness side and ground.

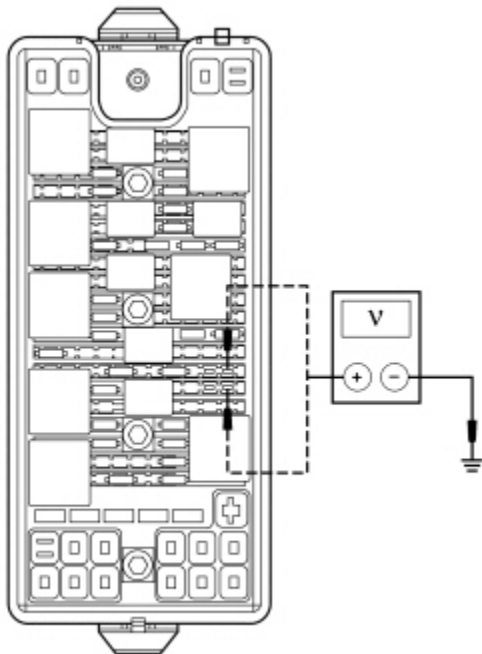

N0025843

Is the voltage greater than 10 volts?

Yes	GO to D4 .
No	REPAIR the circuit. TEST the system for normal operation.

D4 CHECK THE HEATED REAR WINDOW RELAY (NO DTCS)

- Carry out the heated rear window relay component test.
Refer to Wiring Diagrams Cell 149 for component testing.

Is the heated rear window relay ok?

Yes	GO to D5 .
No	INSTALL a new heated rear window relay. TEST the system for normal operation.

D5 CHECK CIRCUIT 186 (BN/LB) FOR AN OPEN

- Disconnect: Heated Rear Window.
- Ignition ON.
- Connect a fused (5A) jumper wire between the heated rear window relay C1099 Pin 30, circuit 298 (VT/OG), harness side and the heated rear window relay C1099 Pin 87, circuit 186 (BN/LB), harness side.

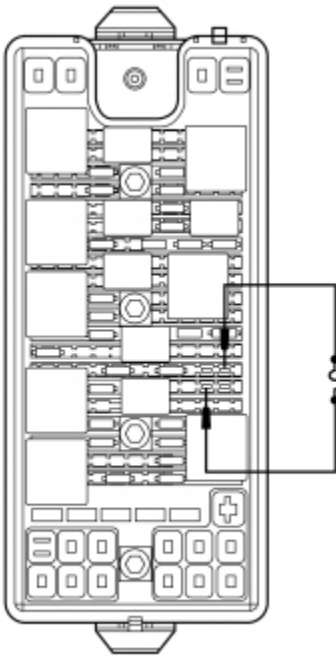

N0025844

- Measure the voltage between the heated rear window C402A Pin 1 (coupe), circuit 186 (BN/LB), harness side and ground; or between the heated rear window C402 Pin 1 (convertible), circuit 186 (BN/LB), harness side and ground.

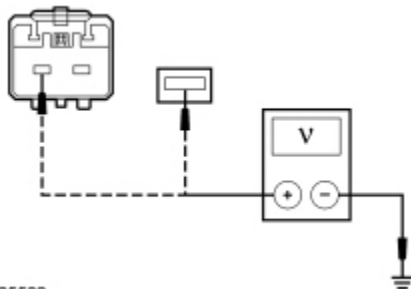

N0025532

Is the voltage greater than 10 volts?

Yes	REMOVE the jumper wire. GO to D6 .
No	REPAIR the circuit. TEST the system for normal operation.

D6 CHECK CIRCUIT 1205 (BK) FOR AN OPEN

- Ignition OFF.
- Measure the resistance between the heated rear window C402B Pin 1 (coupe), circuit 1205 (BK), harness side and ground; or between the heated rear window C402 Pin 2 (convertible), circuit 1205 (BK), harness side and ground.

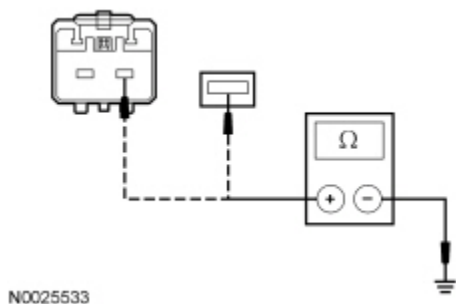

Is the resistance less than 5 ohms?

Yes	REPAIR the heated rear window grid. REFER to Window Grid Wire Repair in this section. TEST the system for normal operation.
No	REPAIR the circuit. TEST the system for normal operation.

D7 CHECK THE HEATED REAR WINDOW SWITCH

NOTE: The use of an analog ohmmeter may be necessary for this step due to the momentary ground signal of the heated rear window switch.

- Ignition OFF.
- Disconnect: SJB C2280b.
- While pressing the heated rear window switch to ON, measure the resistance between the SJB C2280B Pin 18, circuit 1426 (PK), harness side and ground.

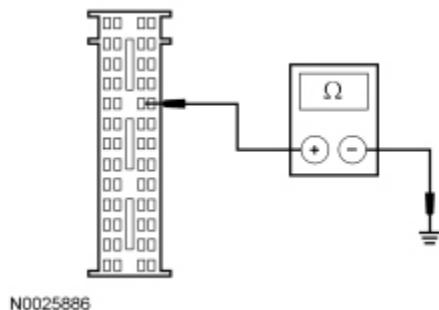

Is the resistance less than 5 ohms?

Yes	GO to D18 .
No	GO to D8 .

D8 CHECK CIRCUIT 1426 (PK) FOR AN OPEN

- Disconnect: Climate Control Assembly C294a.
- Measure the resistance between the SJB C2280B Pin 18, circuit 1426 (PK), harness side and the climate control assembly C294A Pin 10, circuit 1426 (PK), harness side.

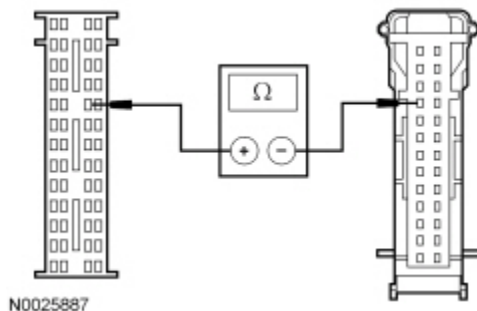

N0025887

Is the resistance less than 5 ohms?

Yes	INSTALL a new climate control assembly. REFER to Section 412-01 . TEST the system for normal operation.
No	REPAIR the circuit. TEST the system for normal operation.

D9 CHECK CIRCUIT 298 (VT/OG) FOR VOLTAGE

- Ignition OFF.
- Disconnect: Heated Rear Window Relay.
- Measure the voltage between the heated rear window relay C1099 Pin 85, circuit 298 (VT/OG), harness side and ground.

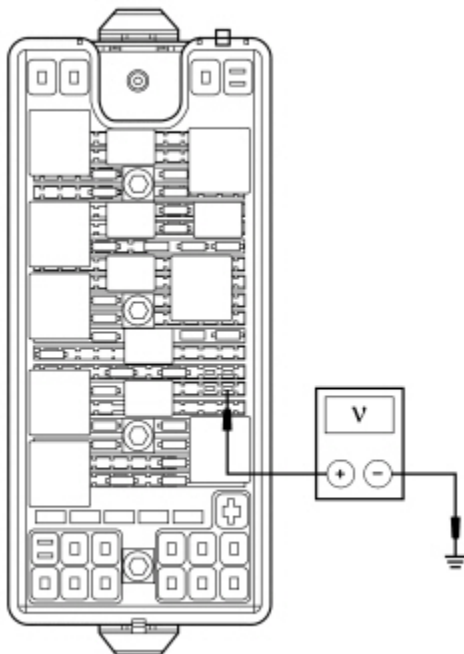

N0025845

Is the voltage greater than 10 volts?

Yes	GO to D10 .
No	REPAIR the circuit. TEST the system for normal operation.

D10 CHECK THE HEATED REAR WINDOW RELAY (DTC B1348, B1349)

- Carry out the heated rear window relay component test. Refer to Wiring Diagrams Cell 149 for component testing.

Is the heated rear window relay ok?

Yes	GO to D11 .
No	INSTALL a new heated rear window relay. TEST the system for normal operation.

D11 CHECK CIRCUIT 1389 (WH) FOR AN OPEN

- Disconnect: SJB C2280c.
- Measure the resistance between the heated rear window relay C1099 Pin 86, circuit 1389 (WH), harness side and the SJB C2280C Pin 12, circuit 1389 (WH), harness side.

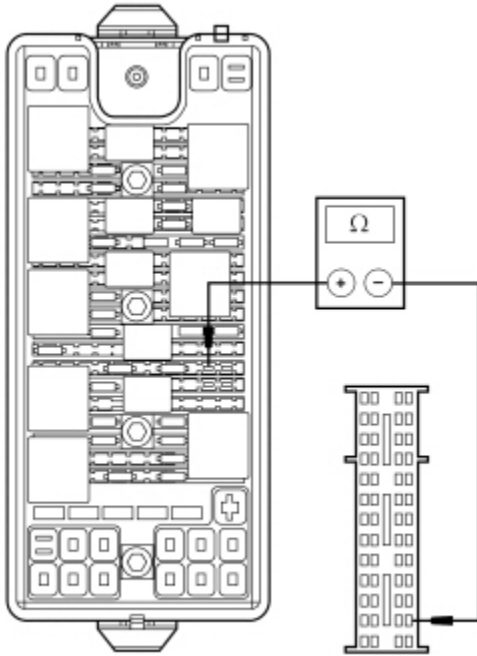

N0025888

Is the resistance less than 5 ohms?

Yes	GO to D12 .
No	REPAIR the circuit. TEST the system for normal operation.

D12 CHECK CIRCUIT 1389 (WH) FOR A SHORT TO VOLTAGE

- Ignition ON.
- Measure the voltage between the heated rear window relay C1099 Pin 86 circuit 1389 (WH), harness side and ground.

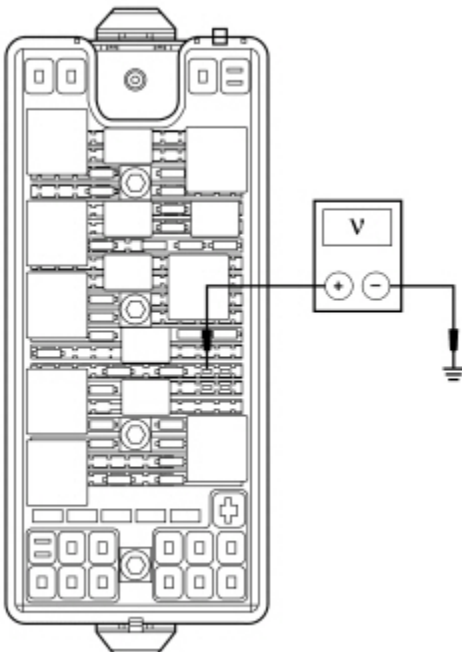

N0025847

Is any voltage present?

Yes	REPAIR the circuit. TEST the system for normal operation.
No	GO to D18 .

D13 VERIFY DTC B1345

- Ignition OFF.
- Disconnect: SJB C2280b.
- Ignition ON.
- Measure the resistance between the SJB C2280B Pin 18 circuit 1426 (PK), harness side and ground.

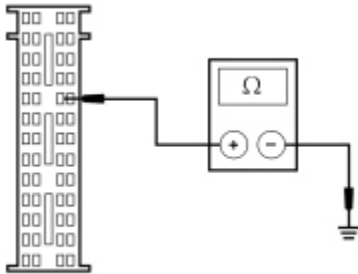

N0025886

Is the resistance greater than 10,000 ohms?

Yes	GO to D18 .
No	GO to D14 .

D14 CHECK CIRCUIT 1426 (PK) FOR A SHORT TO GROUND

- Ignition OFF.
- Disconnect: Climate Control Assembly C294a.
- Measure the resistance between the SJB C2280B Pin 18 circuit 1426 (PK), harness side and ground.

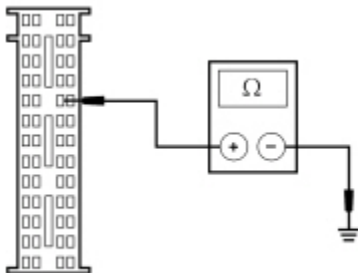

N0025886

Is the resistance greater than 10,000 ohms?

Yes	INSTALL a new climate control assembly. REFER to Section 412-01 . TEST the system for normal operation.
No	REPAIR the circuit. TEST the system for normal operation.

D15 CHECK CIRCUIT 1427 (TN/LB) FOR AN OPEN OR SHORT TO GROUND

- Ignition OFF.
- Disconnect: Climate Control Assembly C294a.
- Disconnect: SJB C2280b.
- Measure the resistance between the SJB C2280B Pin 7 circuit 1427 (TN/LB), harness side and the climate control assembly C294A Pin 4 circuit 1427 (TN/LB), harness side; and between the SJB C2280B Pin 7 circuit 1427 (TN/LB), harness side and

ground.

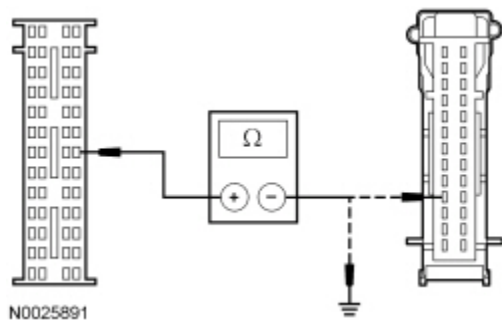

N0025891

Is the resistance less than 5 ohms between the SJB and the climate control assembly; and greater than 10,000 ohms between the SJB and ground?

Yes	GO to D16 .
No	REPAIR the circuit. TEST the system for normal operation.

D16 CHECK CIRCUIT 1427 (TN/LB) FOR A SHORT TO VOLTAGE

- Ignition ON.
- Measure the voltage between the SJB C2280B Pin 7 circuit 1427 (TN/LB), harness side and ground.

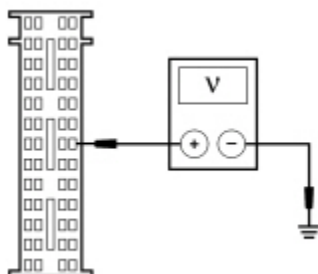

N0025892

Is any voltage present?

Yes	REPAIR the circuit. TEST the system for normal operation.
No	GO to D17 .

D17 CHECK THE CLIMATE CONTROL ASSEMBLY

- Install a known good climate control assembly.
- Operate the heated rear window.

Does the indicator illuminate?

Yes	INSTALL a new climate control assembly. REFER to Section 412-01 . TEST the system for normal operation.
No	GO to D18 .

D18 CHECK THE SJB FOR CORRECT OPERATION

- Disconnect all of the SJB connectors.
- Check for:
 - corrosion
 - pushed-out pins
- Connect all of the SJB connectors and make sure they seat correctly.
- Operate the system and verify the concern is still present.

Is the concern still present?

Yes	INSTALL a new SJB. REFER to Section 419-10 . REPEAT the self-test. TEST the system for normal operation.
No	The system is operating correctly at this time. The concern may have been caused by a loose or corroded connector. CLEAR the DTCs. REPEAT the self-test. TEST the system for normal operation.

Pinpoint Test E: The Defrost System Will Not Shut Off Automatically

Normal Operation

When the rear defrost switch on the climate control assembly is pressed, a signal is sent to the smart junction box (SJB) to ground circuit 1389 (WH). This closes the heated rear window relay, allowing voltage to be supplied to the heated rear window grid through circuit 186 (BN/LB). The heated rear window grid is grounded by circuit 1205 (BK).

Possible Causes

- Circuit 186 (BN/LB) open
- Circuit 1389 (WH) short to ground
- Heated rear window switch
- Heated rear window relay

PINPOINT TEST E : THE DEFROST SYSTEM WILL NOT SHUT OFF AUTOMATICALLY

E1 CHECK THE HEATED REAR WINDOW RELAY

- Ignition ON.
- Disconnect: Heated Rear Window Relay.
- Carry out the heated rear window relay component test. Refer to Wiring Diagrams Cell 149 for component testing.

Does the heated rear window relay pass the component test?

Yes	GO to E2 .
No	INSTALL a new heated rear window relay. TEST the system for normal operation.

E2 CHECK CIRCUIT 186 (BN/LB) FOR A SHORT TO VOLTAGE

- Disconnect: Heated Rear Window C402a (coupe), C402 (convertible).
- Measure the voltage between the heated rear window C402A Pin 1 (coupe), C402 Pin 1 (convertible), circuit 186 (BN/LB), harness side and ground.

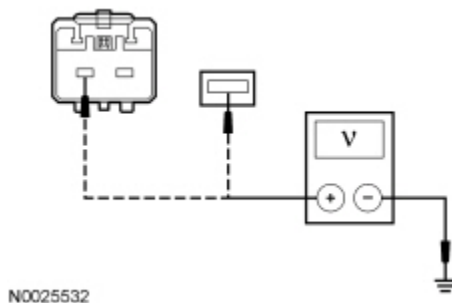

Is the voltage greater than 10 volts?

Yes	REPAIR the circuit. CLEAR the DTCs. REPEAT the self-test. TEST the system for normal operation.
No	GO to E3 .

E3 CHECK CIRCUIT 1389 (WH) FOR A SHORT TO GROUND

- Ignition OFF.
- Disconnect: SJB C2280c.
- Measure the resistance between the heated rear window relay C1099 Pin 86, circuit 1389 (WH), harness side and ground.

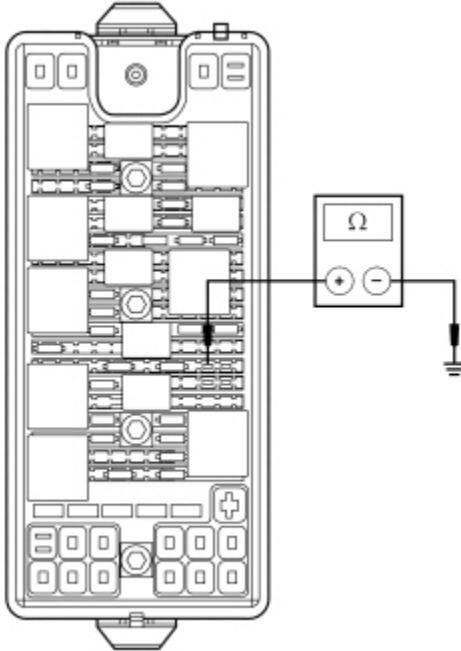

N0025842

Is the resistance greater than 10,000 ohms?

Yes	GO to E4 .
No	REPAIR the circuit. CLEAR the DTCs. REPEAT the self-test. TEST the system for normal operation.

E4 CHECK THE SJB FOR CORRECT OPERATION

- Disconnect all of the SJB connectors.
- Check for:
 - corrosion
 - pushed-out pins
- Connect all of the SJB connectors and make sure they seat correctly.
- Operate the system and verify the concern is still present.

Is the concern still present?

Yes	INSTALL a new SJB. REFER to Section 419-10 . REPEAT the self-test. TEST the system for normal operation.
No	The system is operating correctly at this time. The concern may have been caused by a loose or corroded connector. CLEAR the DTCs. REPEAT the self-test. TEST the system for normal operation.

Pinpoint Test F: The Global Open/Closing Function is Inoperative/Does Not Operate Correctly

Normal Operation

NOTE: The global open/close feature is only available on vehicles equipped with perimeter alarm built before 1/3/2005. This feature is not configurable.

When the unlock button of the remote keyless entry (RKE) transmitter is held for 2 seconds (or the driver door lock cylinder is held in the unlock position for 2 seconds) the global open function activates. The smart junction box (SJB) sends a signal on circuit 2032 (LB) to the driver window and on circuit 2031 (GY/BK) to the passenger window to activate a one-touch down operation of both windows.

When the driver door lock cylinder is held in the lock position for 2 seconds, the global close function activates. The RKE transmitter does not have the function for global close. To stop the global operation, press any RKE transmitter button. The SJB uses circuit 2032 (LB) (driver window) and circuit 2031 (GY/BK) (passenger window) to send a signal to the window motors after which both windows one-touch close. The global open/close feature does not operate if the delayed accessory is active.

Possible Causes

- RKE transmitters
- SJB

PINPOINT TEST F : THE GLOBAL OPEN/CLOSING FUNCTION IS INOPERATIVE/DOES NOT OPERATE CORRECTLY

F1 CHECK THE REMOTE KEYLESS ENTRY (RKE) TRANSMITTERS LOCK/UNLOCK OPERATION

- Operate the RKE lock/unlock function using all of the RKE transmitters.

Does the RKE lock/unlock function operate correctly with at least one of the RKE transmitters?

Yes	GO to F2 .
No	REFER to Section 501-14 to continue diagnosis of the RKE system. TEST the system for normal operation.

F2 CHECK THE RKE TRANSMITTERS GLOBAL OPEN/CLOSE OPERATION

- Operate the global open/close function using all of the RKE transmitters.

Does the global open/close function operate correctly with at least one of the RKE transmitters?

Yes	REPLACE the inoperative RKE transmitter. REFER to Section 501-14 . TEST the system for normal operation.
No	GO to F3 .

F3 CHECK THE SMART JUNCTION BOX (SJB) FOR CORRECT OPERATION

- Disconnect all of the SJB connectors.
- Check for:
 - corrosion
 - pushed-out pins
- Connect all of the SJB connectors and make sure they seat correctly.
- Operate the system and verify the concern is still present.

Is the concern still present?

Yes	INSTALL a new SJB. REFER to Section 419-10 . TEST the system for normal operation.
No	The system is operating correctly at this time. The concern may have been caused by a loose or corroded connector. CLEAR the DTCs. REPEAT the self-test. TEST the system for normal operation.

Pinpoint Test G: The Short Drop Windows Do Not Operate Correctly

Normal Operation

The short drop window feature is activated when one (or both) of the doors are opened which opens a door ajar switch. When the driver door is opened, opening the driver door ajar switch, a signal on circuit 1312 (LG/BK) is interpreted by the driver window motor that the driver door is open. The driver window motor will then carry out the short drop function on the driver window. When the passenger door is opened, opening the passenger door ajar switch, a signal on circuit 1314 (YE/LG) is interpreted by the passenger window motor that the passenger door is open. The passenger window motor will then carry out the short drop function on the passenger window. This feature is on both the coupe and the convertible.

Possible Causes

- Circuit 1312 (LG/BK) open

- Circuit 1314 (YE/LG) open
- Driver window motor
- Passenger window motor

PINPOINT TEST G : THE SHORT DROP WINDOWS DO NOT OPERATE CORRECTLY

G1 VERIFY THE INTERIOR LAMP OPERATION

- Open and close the driver door and view the interior lamps operation.
- Open and close the passenger door and view the interior lamps operation.

Do the interior lamps operate correctly?

Yes	GO to G2 .
No	REFER to Section 417-02 to continue the diagnosis of the interior lamps.

G2 CARRY OUT THE SHORT DROP CALIBRATION

- Ignition ON.
- Carry out the [Window Motor Initialization](#) in this section.

Does the short drop window feature operate correctly?

Yes	The system is operating correctly at this time. INFORM the customer of the short drop window feature. REFER to the Owner's Literature.
No	For the driver window, GO to G3 . For the passenger window, GO to G4 .

G3 CHECK CIRCUIT 1312 (LG/BK) FOR AN OPEN

- Ignition OFF.
- Disconnect: Driver Door Ajar Switch C526.
- Disconnect: Driver Window Motor C518.
- Measure the resistance between the driver window motor C518 Pin 5, circuit 1312 (LG/BK), harness side and the driver door ajar switch C526 Pin 2, circuit 1312 (LG/BK), harness side.

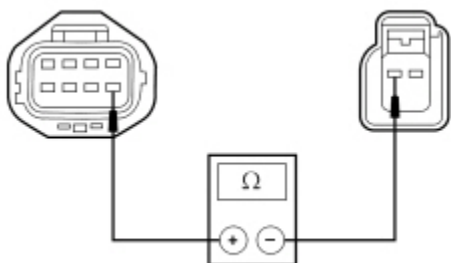

N0025601

Is the resistance less than 5 ohms?

Yes	INSTALL a new driver window motor. REFER to Window Regulator and Motor — Front Door in this section. TEST the system for normal operation.
No	REPAIR the circuit. TEST the system for normal operation.

G4 CHECK CIRCUIT 1314 (YE/LG) FOR AN OPEN

- Ignition OFF.
- Disconnect: Passenger Door Ajar Switch C602.
- Disconnect: Passenger Window Motor C623.
- Measure the resistance between the passenger window motor C623 Pin 5, circuit 1314 (YE/LG), harness side and the passenger door ajar switch C602 Pin 2, circuit 1314 (YE/LG), harness side.

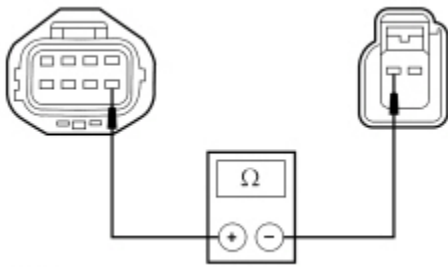

N0025601

Is the resistance less than 5 ohms?

Yes	INSTALL a new passenger window motor. REFER to Window Regulator and Motor — Front Door in this section. TEST the system for normal operation.
No	REPAIR the circuit. TEST the system for normal operation.

Pinpoint Test H: The Convertible Top Drop Function Is Inoperative/Does Not Operate Correctly

Normal Operation

The convertible top drop function is activated when the convertible top switch is operated. When the smart junction box (SJB) sees the voltage drop on circuit 2038 (LB/OG) (lower) or circuit 2052 (VT/OG) (raise), the SJB will first send a signal to all 4 window motors on circuits 2032 (LB) (driver), 2031 (GY/PK) (passenger), 2020 (GY/YE) (LH rear) and 2021 (WH/YE) (RH rear). At this time, all 4 window motors will operate to the fully down position. The rear window motors have a fully down sensor the SJB monitors. When the SJB sees that the LH and RH rear windows are fully down, it will then ground circuit 1174 (WH/RD) (lower relay) or 588 (VT) (raise relay) to close the desired relay and operate the convertible top in the requested direction. If the SJB does not see the correct signal from the LH rear and RH rear window full down sensors, the SJB will not allow the convertible top to operate.

Possible Causes

- Circuit 2032 (LB) open
- Circuit 2031 (GY/PK) open
- Circuit 2020 (GY/YE) open
- Circuit 2021 (WH/YE) open
- Driver window motor
- Passenger window motor
- RH rear window motor
- LH rear window motor
- SJB

PINPOINT TEST H : THE CONVERTIBLE TOP DROP FUNCTION IS INOPERATIVE/DOES NOT OPERATE CORRECTLY

H1 VERIFY THE WINDOW OPERATION

- Ignition ON.
- Open and close all of the windows using the driver window control switches.

Do all of the windows operate correctly?

Yes	GO to H2 .
No	IF the driver window does not operate correctly, GO to Pinpoint Test A . IF the passenger window does not operate correctly, GO to Pinpoint Test B . IF one or both of the rear windows do not operate correctly, GO to Pinpoint Test C .

H2 OPERATE THE CONVERTIBLE TOP

- Attempt to operate the convertible top.

Do the windows drop fully before the convertible top starts to operate?

Yes	The system is operating correctly at this time. INFORM the customer of the convertible top drop function. REFER to the Owner's Literature.
No	FOR the driver or passenger window (or both), GO to H3 . FOR the LH rear window, GO to H6 . FOR the RH rear window, GO to H7 . FOR both rear windows, INSTALL a new SJB. REFER to Section 419-10 . TEST the system for normal operation.

H3 CHECK THE GLOBAL OPEN FEATURE

- Ignition OFF.
- NOTE:** This step will turn off the accessory delay relay. If the accessory delay relay is active, the global open/close feature will not operate.

Fully open and close the driver or passenger door.

- NOTE:** This feature can also be operated by holding the door key in the door lock cylinder in the unlock position for more than 2 seconds (global open), then holding the door key in the door lock cylinder in the lock position for more than 2 seconds (global close).

Operate the global open/close feature by pressing the unlock button on the RKE transmitter for more than 2 seconds (global open), then press the lock button for more than 2 seconds (global close).

Does the global open/close feature operate correctly on both front windows?

Yes	INSTALL a new SJB. REFER to Section 419-10 . REPEAT the self-test. TEST the system for normal operation.
No	FOR the driver window, GO to H4 . FOR the passenger window, GO to H5 . FOR both, INSTALL a new SJB. REFER to Section 419-10 . TEST the system for normal operation.

H4 CHECK CIRCUIT 2032 (LB) FOR AN OPEN OR SHORT TO GROUND

- Disconnect: SJB C2280d.
- Disconnect: Driver Window Motor C518.
- Measure the resistance between the driver window motor C518 Pin 6, circuit 2032 (LB), harness side and the SJB C2280D Pin 5, circuit 2032 (LB), harness side; and between the driver window motor C518 Pin 6, circuit 2032 (LB), harness side and ground.

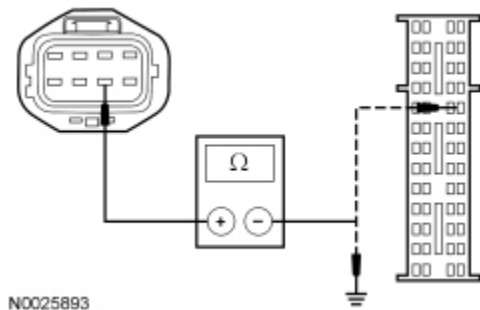

Is the resistance less than 5 ohms between the window motor and the SJB; and greater than 10,000 ohms between the window motor and ground?

Yes	INSTALL a new driver door window regulator and motor. REFER to Window Regulator and Motor — Front Door in this section. TEST the system for normal operation.
No	REPAIR the circuit. TEST the system for normal operation.

H5 CHECK CIRCUIT 2031 (GY/PK) FOR AN OPEN OR SHORT TO GROUND

- Disconnect: SJB C2280d.
- Disconnect: Passenger Window Motor C623.
- Measure the resistance between the passenger window motor C623 Pin 6, circuit 2031 (GY/PK), harness side and the SJB C2280D Pin 6, circuit 2031 (GY/PK), harness side; and between the passenger window motor C623 Pin 6, circuit 2031 (GY/PK), harness side and ground.

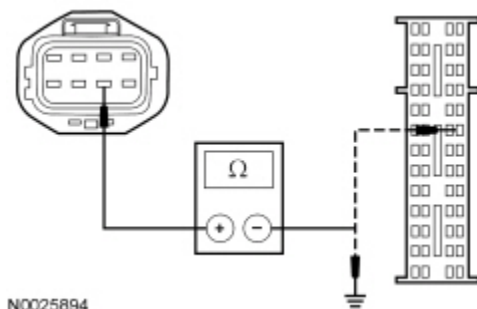

N0025894

Is the resistance less than 5 ohms between the window motor and greater than 10,000 ohms between the window motor and ground?

Yes	INSTALL a new passenger door window regulator and motor. REFER to Window Regulator and Motor — Front Door in this section. TEST the system for normal operation.
No	REPAIR the circuit. TEST the system for normal operation.

H6 CHECK CIRCUIT 2031 (GY/PK) / 2020 (GY/YE) FOR AN OPEN OR SHORT TO GROUND

- Ignition OFF.
- Disconnect: SJB C2280d.
- Disconnect: LH Rear Window Motor C3118.
- Measure the resistance between the LH rear quarter window motor C3118 Pin 6, circuit 2031 (GY/PK), harness side and the SJB C2280D Pin 19, circuit 2020 (GY/YE), harness side; and between the LH rear quarter window motor C3118 Pin 6, circuit 2031 (GY/PK), harness side and ground.

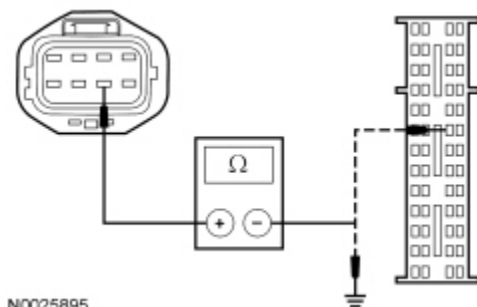

N0025895

Is the resistance less than 5 ohms between the window motor and greater than 10,000 ohms between the window motor and ground?

Yes	INSTALL a new LH rear quarter window regulator and motor. REFER to Window Regulator Motor — Rear Quarter in this section. TEST the system for normal operation.
No	REPAIR the circuit. TEST the system for normal operation.

H7 CHECK CIRCUIT 2031 (GY/PK) / 2021 (WH/YE) FOR AN OPEN OR SHORT TO GROUND

- Ignition OFF.
- Disconnect: SJB C2280d.
- Disconnect: RH Rear Window Motor C3119.
- Measure the resistance between the RH rear quarter window motor C3119 Pin 6, circuit 2031 (GY/PK), harness side and the SJB C2280D Pin 20, circuit 2021 (WH/YE), harness side; and between the RH rear quarter window motor C3119 Pin 6, circuit 2031 (GY/PK), harness side and ground.

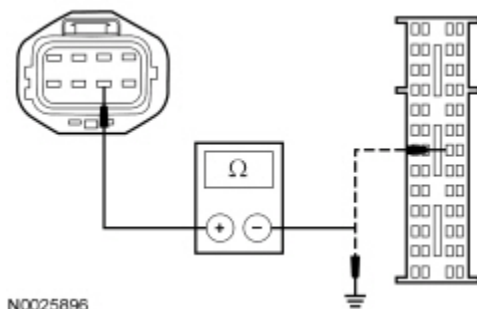

Is the resistance less than 5 ohms between the window motor and greater than 10,000 ohms between the window motor and ground?

Yes	INSTALL a new RH rear quarter window regulator and motor. REFER to Window Regulator Motor — Rear Quarter in this section. TEST the system for normal operation.
No	REPAIR the circuit. TEST the system for normal operation.

Component Tests

Grid Wire Test

1. Using a bright lamp inside the vehicle, inspect the wire grid from the exterior. A broken grid wire appears as a brown spot.
2. Run the engine at idle. Set the heated rear window switch to ON. The heated rear window indicator should come on.
3. Working from the interior of the vehicle with a voltmeter, contact the broad red-brown stripes of the heated rear window positive lead to battery side and the negative lead to ground side. The meter should read 10-13 volts. A lower voltage reading indicates a loose ground connection.
4. Contact a good ground point with the negative lead of the meter. The voltage reading should not differ.
5. With the negative lead of the meter grounded, touch each grid line of the heated rear window at its midpoint with the positive lead. A reading of approximately 6 volts indicates the line is good. A reading of zero volts indicates the line is broken between the midpoint and the B+ side of the grid line. A reading of 12 volts indicates the circuit is broken between the midpoint of the grid line and ground.