

Diagnostics

Diagnosing an electronically controlled transmission is simplified by using the following procedures. One of the most important things to remember is that there is a definite procedure to follow. **DO NOT TAKE SHORT CUTS OR ASSUME THAT CRITICAL CHECKS OR ADJUSTMENTS HAVE BEEN MADE.** Follow the procedures as written to avoid missing critical components or steps. By following the diagnostic sequence, the service technician will be able to diagnose and repair the concern the first time.

On-Board Diagnostics with NGS

The Quick Tests are in the Powertrain Control/Emissions Diagnosis Manual. These tests can be used to diagnose the powertrain control module (PCM) (12A650) , sensors and actuators of the 4R70W transmission.

The following is a guide for using the On-Board Diagnostic (OBD) Quick Tests and the Rotunda New Generation Star (NGS) Tester 418-F048 (007-00500), with some special considerations to remember:

For detailed instructions and other diagnostic methods using the NGS, refer to the Powertrain Control/Emissions Diagnosis Manual or NGS instruction guide.

If using a generic scan tool, refer to the Powertrain Control/Emissions Diagnosis Manual for instructions on performing OBD procedures.

Quick Test 1.0—Visual Inspection

Perform the Visual Check and Vehicle Preparation procedures as described in the Powertrain Control/Emissions Diagnosis Manual.

Inspect the following:

- air cleaner and inlet ducting
- all engine vacuum hoses for damage: leaks, cracks, blockage, proper routing, etc.
- PCM system wiring harnesses for proper connections, bent or broken pins, corrosion, loose wires, proper routing, etc.
- powertrain control module, sensors and actuators for physical damage
- engine coolant for proper level
- transmission fluid for proper level and condition
- any NON-factory installed items wired into the transmission or PCM harnesses

NOTE: Perform all necessary servicing before continuing with Quick Tests.

Quick Test 2.0—Set Up

Connect Rotunda New Generation Star (NGS) Tester 418-F048 (007-00500) or equivalent to data link connector (DLC).

The following are procedures to run OBD II procedures.

Vehicle and Tester Preparation

Prepare the vehicle as follows:

- Place transmission range selector lever in PARK.
- Run engine to operating temperature.
- Apply parking brake.
- Block wheels.
- Turn off all electrical loads including A/C and defroster. (If A/C is ON, DTC P1460 will set.)

Prepare the NGS as follows:

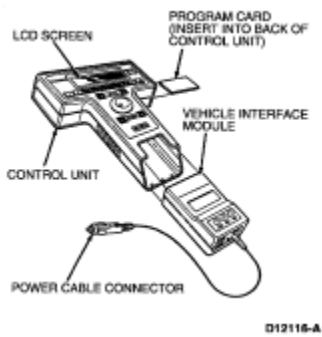

- Turn ignition switch to the OFF position.
- Verify that the proper PROGRAM card is inserted in the NGS.
- Connect J1962/16 way data communication link (DCL) cable adapter to the NGS.
- Connect NGS DCL cable adapter securely into the vehicle's data link connector.
- Connect the NGS power supply cable to the vehicle battery power supply through cigar lighter or at the battery with alligator clip adapter.
- Turn the ignition switch to the RUN position, or start vehicle if necessary.
- The NGS is now ready to communicate with the PCM.

NOTE: Do not replace parts based on a code, perform Pinpoint Tests first.

Quick Test 3.0—Key On, Engine Off (KOEO)

Some special considerations for Key On, Engine Off Quick Test include the following:

- The KOEO test provides hard Diagnostic Trouble Codes (DTCs) present at the time of testing.
- Always service the hard DTCs first.

Performing KOEO

- Perform visual inspection and vehicle preparation as required.
- Select "Vehicle and Engine Selection" menu.
- Select year, engine, model with the appropriate qualifier if needed, for example, transmission or 49 state/California.
- Select "Diagnostic Data Link" menu.
- Select "Output Test Mode" menu.
- Select "KOEO On-Demand Self-Test."
- Follow operating instructions from the NGS menu screen.
- Record all DTCs displayed.
- Service NON-transmission DTCs first as they can directly affect the operation of the transmission. Road test and repeat Quick Test to verify the service.

Quick Test 4.0—Continuous Memory Codes

Continuous DTCs are concerns which were detected during normal vehicle operation. These codes are retained for 40 warm-up cycles.

Some special considerations for continuous testing include the following:

- The cause of some continuous DTCs may have been eliminated if KOEO and/or KOER DTCs were serviced. Always re-test and service any DTCs that still remain.
- If DTCs are present, go to the On-Board Diagnostic Trouble Code Description Chart for service information. Erase DTC, perform the Transmission Drive Cycle Test and repeat all Quick Test procedures after completing service on the DTCs.
- If the continuous test passes (P1111) and a concern is still present, refer to Diagnosis by Symptom, OASIS and TSBs for concern diagnosis.

Performing Continuous Memory Codes

- Select "Vehicle and Engine Selection" menu.
- Select year, engine and model with the appropriate qualifier if needed, for example, transmission or 49 state/California.
- Select "Diagnostic Data Link" menu.
- Select "Output Test Mode" menu.
- Select "Retrieve Continuous Codes" menu.
- Follow operating instructions from the NGS menu screen.
- Record all DTCs displayed.
- Perform Transmission Drive Cycle Test.

- Rerun Continuous DTC Test, if DTCs have returned, and service as required. Road test and rerun all DTC test procedures.

Quick Test 5.0—Key On Engine Running (KOER)

The Engine Running Quick-Test provides hard DTCs only.

Some special considerations for KOER Quick-Test include the following:

- Follow the menu screen instructions as they appear.
- If a DTC appears after the KOER test, a malfunction is present. Refer to the On-Board Diagnostic Trouble Code Description Chart for service information.

Performing KOER

- Perform visual inspection and vehicle preparation as required.
- Select "Vehicle and Engine Selection" menu.
- Select year, engine and model with the appropriate qualifier if needed, for example, transmission or 49 state/California.
- Select "Diagnostic Data Link" menu.
- Select "Output Test Mode" menu.
- Select "KOER On-Demand Self-Test."
- Follow operating instructions from the NGS menu screen (example: turn key on, etc.) and perform brake on/off and cycle the transmission control switch (TCS) on and off, if equipped.
- Record all DTCs displayed.
- Service all NON-transmission DTCs first as they can directly affect the operation of the transmission. Road test and repeat Quick Test to verify service.

Special Test Modes

- Output test modes.
- PCM Reset Mode (Clearing DTCs)

Output Test Mode



CAUTION: Safety must be observed when using output test mode. When all outputs are on and the electric fuel pump is energized, make sure the fuel system is intact and is not being serviced at that time. When low speed or high speed cooling fans are turned on, make sure fan blades are clear of any obstruction.

NOTE: As a safety precaution, the Output Test Mode will default to its normal state after ten minutes, after the vehicle is started or after cycling the ignition switch off and on.

The Output Test Mode (OTM) aids in servicing output actuators associated with the PCM. It allows the technician to energize and de-energize most of the system output actuators on command. When entering OTM, the outputs can be turned off and on without controlling the cooling fans. The low and high speed cooling fans may be turned on separately without energizing the other outputs.

Performing Output Test Mode

Enter OTM with the ignition key on and the engine off.

- Perform the necessary vehicle preparation and visual inspection.
- Connect scan tool to DLC.
- Select VEHICLE and ENGINE SELECTION menu.
- Select NEW VEHICLE YEAR and MODEL.
- Enter year, engine, model with the appropriate qualifier, if needed (i.e., transmission, 49 state or California).
- Select DIAGNOSTIC DATA LINK.
- Select PCM - POWERTRAIN CTRL MODULE.
- Select ACTIVE COMMAND MODES.
- Select OUTPUT TEST MODE.
- Turn key on.
- Follow operating instructions from the menu.
- Select the mode (i.e., ALL ON, ALL OFF, HIGH SPEED FAN or LOW SPEED FAN)
- Select START to turn outputs ON (may link up to PIDs).
- Select STOP to turn outputs OFF.

Output State Control (OSC) Mode

Output State Control (OSC) allows the technician to take control of certain parameters to function the transmission. For example, OSC allows the technician to shift the transmission only when he/she commands a gear change. If the technician commands 1st gear in OSC, the transmission will remain in 1st gear until the technician commands the next gear. Another example, the technician

can command a shift solenoid to turn on or off when performing an electrical circuit check. OSC has two modes of operation for transmission, the BENCH MODE and the DRIVE MODE. Each mode/parameter has a unique set of vehicle operating requirements that the technician is required to meet before being allowed to operate OSC.

NOTE: To operate OSC the Digital Transmission Range (TR) Sensor and the Vehicle Speed Sensor (VSS) must be operational. No Diagnostic Trouble Codes (DTCs) related to the TR sensor or the VSS sensor can be present.

- The vehicle requirements MUST BE MET when SENDING the OSC value. Refer to individual test modes for vehicle requirement.
- If the vehicle requirements are NOT MET when SENDING the OSC value, an ERROR MESSAGE will appear. When the ERROR MESSAGE is received, OSC is aborted and must be restarted.
- If AFTER SENDING an OSC value, and the vehicle requirements are no longer met, the PCM will cancel the OSC value and NO ERROR message will appear.
- The OSC value [XXX] may be sent anytime to cancel OSC.

Output State Control (OSC) Procedures:

- Perform visual inspection and vehicle preparation as required.
- Select "Vehicle and Engine Selection" menu.
- Select appropriate vehicle and engine.
- Select "Diagnostic Data Link."
- Select "Powertrain Control Module."
- Select "Diagnostic Test Mode."
- Select "KOEO On-Demand Self Test and KOER On-Demand Self Tests."
- Perform test and record DTCs.
- Repair all NON-Transmission DTCs.
- Repair all VSS and Digital TR Sensor DTCs.
- Ensure that VSS/Digital TR Sensors are functional.
- Select "Active Command Modes."
- Select "Trans - Bench Mode or Trans - Drive Mode."

OSC — Transmission Bench Modes

The following Transmission Bench Modes may be used or required during diagnostics.

SSA/SS1, SSB/SS2 and TCC in BENCH MODE:

The BENCH MODE allows the technician to perform electrical circuit checks on the following components:

- SSA/SS1 - Activates SS#1 OFF or ON.
- SSB/SS2 - Activates SS#2 OFF or ON.
- TCC - Activates TCC OFF or ON.

OSC "SSA/SS1, SSB/SS2, TCC" BENCH MODE Operates ONLY when:

- VSS and Digital TR Sensor are operational.
- No VSS and Digital TR Sensor DTCs.
- Transmission Range Selector Lever in P.
- Key ON.
- Engine OFF.

OSC Command Values:

- [OFF] - turns solenoid OFF.
- [ON] - turns solenoid ON.
- [XXX] - cancels OSC value sent.
- [SEND] - sends the values to PCM.

BENCH MODE Procedure for SSA/SS1, SSB/SS2, and TCC

Follow operating instructions from the NGS menu screen:

- Select "Output State Control."
- Select "Trans - Bench Mode."
- Select "PIDs" to be monitored.
- Monitor all selected PIDs during test.
- Select "Parameters - SSA/SS1, SSB/SS2 or TCC."
- Select "ON" to turn solenoid ON.
- Press "SEND" to send command ON.

- Select "OFF" to turn solenoid OFF.
- Press "SEND" to send command OFF.
- Select "XXX" to cancel at any time.
- Press "SEND".

EPC in BENCH MODE:

The BENCH MODE is also used to test the functionality of the transmission's electronic pressure control. During BENCH MODE, the EPC solenoid can ramp in increments of 15 psi from zero to 90 psi and 90 to zero psi.

The OSC functions for the parameter EPC allows the technician to choose the following options:

- EPC - Activates EPC to selected values.
- [00] - sets EPC pressure to 00 PSI.
- [15] - sets EPC pressure to 15 PSI.
- [30] - sets EPC pressure to 30 PSI.
- [45] - sets EPC pressure to 45 PSI.
- [60] - sets EPC pressure to 60 PSI.
- [75] - sets EPC pressure to 75 PSI.
- [90] - sets EPC pressure to 90 PSI.

OSC "EPC" BENCH MODE Operates ONLY when:

- VSS and digital TR Sensor are operational.
- No VSS and digital TR Sensor DTCs.
- Transmission Range Selector Lever in P.
- Pressure gauge installed.
- Key ON.
- Engine ON.
- Engine RPM at 1500.

OSC Command Values:

- [00] - sets EPC pressure to 00 PSI.
- [15] - sets EPC pressure to 15 PSI.
- [30] - sets EPC pressure to 30 PSI.
- [45] - sets EPC pressure to 45 PSI.
- [60] - sets EPC pressure to 60 PSI.
- [75] - sets EPC pressure to 75 PSI.
- [90] - sets EPC pressure to 90 PSI.
- [OFF] - turns solenoid off.
- [ON] - turns solenoid on.
- [XXX] - cancels OSC value sent.
- [SEND] - sends the values to PCM.

BENCH MODE Procedure for EPC

Following operating instructions from the NGS menu screen.

- Select "Output State Control."
- Select "Trans - Bench Mode."
- Select "PIDs" to be monitored.
- Monitor all selected PIDs during test.
- Select "Parameters - EPC."
- Select Value "0 - 90 psi."
- Press "SEND" to send command.
- Select "XXX" to cancel at any time.
- Press "SEND"

OSC — Transmission DRIVE MODES

The DRIVE MODE allows control of three transmission parameters. Each mode/parameter has a unique set of vehicle operating requirements that the technician is required to meet before being allowed to operate OSC. The recommended procedure, when using the DRIVE MODE, is to control one parameter at a time.

The DRIVE MODE allows the technician to perform the following functions on the transmission:

- GR_CM - allows upshifts or downshifts.
- TCC - engages or disengages the torque converter clutch.

- EPC - increases/decreases EPC pressure.

GR_CM in DRIVE MODE

This OSC function is used to test the transmission shift functions.

The OSC functions for the GR_CM parameter allows the technician to choose the following options:

- [1] - PCM selects 1st gear.
- [2] - PCM selects 2nd gear.
- [3] - PCM selects 3rd gear.
- [4] - PCM selects 4th gear.

OSC "GR_CM" Mode Operates ONLY when:

- VSS and digital TR Sensor are operational.
- No VSS and digital TR Sensor DTCs.
- Engine "ON."
- TCC "OFF."
- Transmission Range Selector Lever on O/D.
- Vehicle Speed is greater than 2 mph.

OSC Command Values:

- [1] - PCM selects 1st gear.
- [2] - PCM selects 2nd gear.
- [3] - PCM selects 3rd gear.
- [4] - PCM selects 4th gear.
- [OFF] - turns solenoid off.
- [ON] - turns solenoid on.
- [XXX] - cancels OSC value sent.
- [SEND] - sends the values to PCM.

DRIVE MODE Procedure for GR_CM

Follow operating instructions from the NGS menu screen.

- Select "Output State Control."
- Select "Trans - DRIVE MODE."
- Select "PIDs" to be monitored.
- Monitor all selected PIDs during test.
- Select "Parameters - GR_CM."
- Select Value "1-5."
- Press "SEND" to send command.
- Re-Select Value "1-5."
- Press "SEND" to send command.
- Select "XXX" to cancel at any time.
- Press "SEND."

TCC in DRIVE MODE:

This OSC function is used to test whether the torque converter clutch is engaging and disengaging correctly.

The OSC functions for the TCC parameter allows the technician to choose the following:

- TCC - activates TCC OFF and ON.
- [ON] - turns TCC solenoid ON.
- [OFF] - turns TCC solenoid OFF.

OSC "TCC OFF" DRIVE MODE Operates ONLY when:

- VSS and digital TR Sensors are operational.
- No VSS and digital TR Sensor DTCs present.
- Engine ON.
- Transmission Range Selector Lever in O/D.
- Vehicle speed is greater than 2 mph.

OSC "TCC ON" DRIVE MODE Operates ONLY when:

- VSS and digital TR Sensors are operational.
- No VSS and digital TR Sensor DTCs present.
- Engine ON.
- Transmission Range Selector Lever in O/D.
- Vehicle speed is greater than 2 mph.
- Transmission in 2nd gear or higher.
- TFT is between 60 and 275 degrees F.
- Brake not applied "OFF" below 20 mph.
- (Not an excessive load on engine (engine lugging)).

OSC Command Values:

- [OFF] - turns TCC OFF.
- [ON] - turns TCC ON.
- [XXX] - cancels OSC value sent.
- [SEND] - sends the values to PCM.

Drive Mode Procedures for TCC

Follow operating instructions from the NGS menu screen.

- Select "Output State Control."
- Select "Trans - Drive Mode."
- Select "PIDs" to be monitored.
- Monitor all selected PIDs during test.
- Select "Parameters - TCC."
- Select "ON" to turn solenoid ON.
- Press "SEND" to send command ON.
- Select "OFF" to turn solenoid OFF.
- Press "SEND" to send command OFF.
- Select "XXX" to cancel at any time.
- Press "SEND."

EPC in DRIVE MODE

This OSC function is used to increase the EPC pressure while testing the transmission shift functions. This OSC function can only increase the EPC pressure greater than what the PCM normally commands. If an OSC value, such as [75] or [90] PSI is sent, the upshifts and downshifts should exhibit a harsher shift. Harsher shifts would indicate that the EPC pressure control works at higher pressures. The best test for the EPC is to use the BENCH MODE and a hydraulic pressure gauge. Using EPC in the BENCH MODE will confirm that the EPC works at both the higher and lower pressures.

The OSC functions for the parameter EPC allows the technician to choose the following options:

- EPC - Activates EPC to selected
 - [00] - sets EPC pressure to 00 PSI.
 - [15] - sets EPC pressure to 15 PSI.
 - [30] - sets EPC pressure to 30 PSI.
 - [45] - sets EPC pressure to 45 PSI.
 - [60] - sets EPC pressure to 60 PSI.
 - [75] - sets EPC pressure to 75 PSI.
 - [90] - sets EPC pressure to 90 PSI.

OSC "EPC" DRIVE MODE Operates ONLY when:

- VSS and digital TR Sensor are operational.
- No VSS and digital TR Sensor DTCs.
- Transmission Range Selector Lever in O/D.
- Pressure gauge installed.
- Key ON.
- Engine ON.
- Vehicle speed greater than 2 mph.
- OSC value for EPC must be greater than what the PCM commands (see EPC PID).

OSC Command Values:

- [00] - sets EPC pressure to 00 PSI.
- [15] - sets EPC pressure to 15 PSI.
- [30] - sets EPC pressure to 30 PSI.
- [45] - sets EPC pressure to 45 PSI.

- [60] - sets EPC pressure to 60 PSI.
- [75] - sets EPC pressure to 75 PSI.
- [90] - sets EPC pressure to 90 PSI.
- [OFF] - turns solenoid off.
- [ON] - turns solenoid on.
- [XXX] - cancels OSC value sent.
- [SEND] - sends the values to PCM.

DRIVE MODE Procedure for EPC.

Follow operating instructions from the NGS menu screen.

- Select "Output State Control."
- Select "Trans - Drive Mode."
- Select "PIDs" to be monitored.
- Monitor all selected PIDs during test.
- Select "Parameters - EPC."
- Select Value "0-90 psi."
- Press "SEND" to send command.
- Re-Select Value "0-90 psi."
- Press "SEND" to send command.
- Select "XXX" to cancel at any time.
- Press "SEND."

Using Output State Control (OSC) and Accessing PIDs

To confirm that the OSC value was sent by the NGS and the EEC has accepted the OSC substitution, a corresponding PID for each OSC parameter must be monitored. Additional PIDs should be monitored to help the technician adequately diagnose the transmission.

The following is a list of OSC parameters and their corresponding PID:

OSC Parameter	Corresponding PID	Additional PIDs
SSA/SS1	SSA/SS1	SSA/SS1F
SSB/SS2	SSB/SS2	SSB/SS2F
TCC	TCC	TCCF, TCCMACT (do not use PID TCCMCMD during OSC)
EPC	EPC	—
GR_CM	GEAR	TRANRAT

To confirm that the OSC substitution occurred, SEND the OSC value and monitor the corresponding PID value. If no ERROR MESSAGE was received and the value of the corresponding PID remains the same as the value sent from OSC, then the OSC substitution was successful.

PCM Reset Mode

The PCM reset mode provides a means for the NGS to command the PCM to clear all DTCs. When resetting the PCM, a DTC P1000 will be set in the PCM until all OBD II system or components have been monitored during OBD II drive cycle.

A PCM reset:

- clears the DTCs.
- clears the Freeze Frame Data.
- clears the Oxygen Sensor Test Data.
- resets the status of the OBD II System Monitors.
- sets the DTC P1000.

Performing PCM Reset

- Perform visual inspection and vehicle preparation as required.
- Select "Vehicle and Engine Selection" menu.
- Select year, engine, model with the appropriate qualifier if needed, for example, transmission or 49 state/California.
- Select "Generic OBD II Functions" menu.
- Select "Clearing ALL Codes."
- Follow operating instructions from the NGS menu screen.

- Perform OBD II Drive Cycle—Clear DTC P1000.

Clearing DTC #P1000

In some localities it may become a legal requirement to pass an Inspection/Maintenance (I/M) test of the OBD II System. If the vehicle's OBD II system or its battery has just been serviced, the PCM system is reset to a "not ready for I/M testing" condition. To prepare the vehicle for this test and to clear the DTC P1000, the OBD II drive cycle must be performed.

OBD II Drive Cycle

The following Steps **MUST BE RUN IN THE ORDER SHOWN**. If Steps 2, 3 or 4 are interrupted, repeat the step before proceeding. Any safe driving mode is acceptable between steps.

Always drive vehicle in a safe manner according to traffic conditions and obey all traffic laws.

1. Start engine and drive vehicle in typical city stop and go traffic for at least 10 minutes after it has reached normal operating temperature.
2. Idle vehicle for at least 45 seconds, then accelerate at part throttle to near 72 km/h (45 mph).
3. Cruise and maintain a select speed in the range of 48 to 64 km/h (30 to 40 mph) on a level road with throttle held steady for at least one minute.
4. Cruise and maintain a select speed in the range of 64 to 105 km/h (40 to 65 mph) on a level road with throttle held steady for at least one minute and 20 seconds.
5. OBD II drive cycle has been completed.

Other NGS Features

For further information on other diagnostic testing features using the NGS or generic scan tool, refer to the Powertrain Control/Emissions Diagnosis Manual.

Other diagnostic methods include the following:

- Parameter Identification (PID) Access Mode, used to monitor sensors and actuators.
- Freeze Frame Data Access Mode, used to view emission related data values from specific PIDs.
- Oxygen Sensor Monitor Mode, used to monitor the Heated Oxygen (HO2S) sensor.

Transmission Drive Cycle Test

NOTE: Always drive the vehicle in a safe manner according to driving conditions and obey all traffic laws.

After performing the Quick Test, use the following Transmission Drive Cycle Test for checking transmission continuous codes:

NOTE: The Transmission Drive Cycle Test must be followed exactly. A malfunction must occur four times consecutively for DTCs P0781, P1731, P0782, P1732, P0783, P1733 to be set, and five times consecutively for continuous DTC P0741.

1. Record and then erase Quick Test DTCs.
2. Warm engine to normal operating temperature.
3. Make sure transmission fluid level is correct.
4. With transmission In OVERDRIVE, moderately accelerate from stop to 80 Km/h (50 mph). This allows the transmission to shift into fourth gear. Hold speed and throttle open steady for a minimum of 15 seconds.
5. With transmission in OVERDRIVE, press TCS (TCIL should illuminate) and moderately accelerate from stop to 64 Km/h (40 mph). This allows transmission to shift into third gear. Hold speed and throttle open steady for a minimum of 15 seconds (30 seconds above 1220 meters (4000 ft)).
6. Press TCS (TCIL should turn off) and accelerate from 64Km/h (40 mph) to 80 Km/h (50 mph). This allows transmission to shift into fourth gear. Hold speed and throttle position steady for a minimum of 15 seconds.
7. With transmission in fourth gear and maintaining steady speed and throttle opening, lightly apply and release brake (to operate stoplamps). Then hold speed and throttle steady for an additional five seconds minimum.
8. Brake to a stop and remain stopped for a minimum of 20 seconds.

9. Repeat Steps 4 through 8 at least five times.

10. Perform Quick Test and record continuous DTCs.

After On-Board Diagnostics

NOTE: The vehicle wiring harness, powertrain control module and non-transmission sensors may affect transmission operations. Service these concerns first.

NOTE: After electrical diagnosis has been performed and a concern still exists, refer to the Diagnosis by Symptom Index.

Begin with non-transmission related DTCs, then service any transmission related DTCs. Refer to the On-Board Diagnostic Trouble Code Description Chart for information on condition and symptoms. This chart will be helpful in referring to the proper manual(s) and to aid in diagnosing internal transmission concerns and external non-transmission inputs. The pinpoint tests are used in diagnosing electrical concerns of the 4R70W transmission. Make sure that the vehicle wiring harness and the powertrain control module are diagnosed as well. The Powertrain Control/Emissions Diagnosis Manual will aid in diagnosing non-transmission electronic components.

Before Pinpoint Tests

NOTE: Prior to entering pinpoint tests, check the PCM wiring harness for proper connections, bent or broken pins, corrosion, loose wires, proper routing, proper seals and their condition. Check the powertrain control module, sensors and actuators for damage. Refer to the Powertrain Control/Emissions Diagnosis Manual.

If DTCs appear, while performing the on-board diagnostics, refer to the On-Board Diagnostic Trouble Code Description Chart for the appropriate service procedure. Prior to entering the pinpoint tests, refer to any TSBs and OASIS messages for 4R70W transmission concerns.

Diagnostic Trouble Code Chart

Refer to the On-Board Diagnostic Trouble Code Description Chart for information on condition and symptoms. This chart will be helpful in referring to the proper manual(s) and to aid in diagnosing internal transmission concerns and external non-transmission inputs. The pinpoint tests are used in diagnosing electrical concerns of the transmission. Make sure that the vehicle wiring harness and the powertrain control module are diagnosed as well. The Powertrain Control/Emissions Diagnosis Manual will aid in diagnosing non-transmission electronic components.

NOTE: The vehicle wiring harness, powertrain control module and non-transmission sensors may affect transmission operations. Service these concerns first.

ON-BOARD DIAGNOSTIC TROUBLE CODE DESCRIPTION CHART

*Output circuit check, generated only by electrical symptoms.					
**May also be generated by some other non-electric transmission hardware system.					
Four Digit DTC	Component	Description	Condition	Symptom	Action
P0112	IAT	IAT indicates 125°C (257°F) (grounded)	Voltage drop across IAT exceeds scale set for temperature 125°C (257°F).	Incorrect EPC pressure. Either high or low which will result in harsh or soft shifts.	Refer to PC/ED ¹
P0113	IAT	IAT indicates -40°C (-40°F) (open circuit)	Voltage drop across IAT exceeds scale set for temperature -40°C (-40°F).	Incorrect EPC pressure. Either high or low which will result in harsh or soft shifts.	Refer to PC/ED ¹
P0114	IAT	IAT out of on-board diagnostic range	IAT temperature higher or lower than expected during KOEO and KOER.	Rerun on-board diagnostic at normal operating temperature.	Refer to PC/ED ¹

P1116	ECT	ECT out of on-board diagnostic range	ECT temperature higher or lower than expected during KOEO and KOER.	Rerun on-board diagnostic at normal operating temperature.	Refer to PC/ED ¹
P0117	ECT	ECT indicates 125°C (257°F)	Voltage drop across ECT exceeds scale set for temperature 125°C (257°F) (grounded).	Torque converter clutch will always be off, resulting in reduced fuel economy.	Refer to PC/ED ¹
P0118	ECT	ECT indicates -40°C (-40 °F)	Voltage drop across ECT exceeds scale set for temperature -40 °C (-40°F) (open circuit).	Torque converter clutch will always be off, resulting in reduced fuel economy.	Refer to PC/ED ¹
P1117	ECT	Intermittent ECT signal to PCM.	PCM has detected an intermittent signal.	Incorrect EPC pressure. Either high or low will result in harsh or soft shifts.	Refer to PC/ED ¹
P1124	TP	TP voltage high/low for on-board diagnostic.	TP was not in the correct position for on-board diagnostic.	Rerun at appropriate throttle position per application.	Refer to PC/ED ¹
P0122, P0123, P1120	TP	TP concern	PCM has detected an error. This error may cause a transmission concern.	Harsh engagements, firm shift feel, abnormal shift schedule, torque converter clutch does not engage. Torque converter clutch cycling.	Refer to PC/ED ¹
P0102, P0103, P1100, P1101	MAF	MAF concerns	MAF system has a malfunction which may cause a transmission concern.	High/low EPC pressure, incorrect shift schedule. Incorrect torque converter clutch engagement scheduling. Symptoms similar to a TP failure.	Refer to PC/ED ¹
P0300-P0308 P0320, P0340 P1351-P1364	EI	EI System	EI system has a malfunction which may cause a transmission concern.	Harsh engagements and shifts, late WOT shifts, no torque converter clutch engagement.	Refer to PC/ED ¹
P0501, P0503, P1500, P1501, P0501	VSS	Insufficient VSS input.	PCM detected a loss of vehicle speed signal during operation.	Torque converter clutch engages, shift engagement/disengagement (hunting) on grades.	Refer to PC/ED ¹
P1703	BPP	Brake not actuated during on-board diagnostic.	Brake not cycled during KOER.	Failed OFF or not connected—torque converter clutch will not engage at less than 1/3 throttle. Failed OFF or not connected — torque converter clutch will not disengage when brake is applied.	Refer to PC/ED ¹
P1703	BPP	BPP switch circuit failed.	Brake Pedal Position circuit failure.	Failed ON or not connected—torque converter clutch will not engage at less than 1/3 throttle. Failed OFF or not connected—torque converter clutch will not disengage when brake is applied.	Refer to PC/ED ¹
P1460	A/C	A/C clutch cycling pressure switch error	A/C or Defrost ON condition may result from A/C clutch being ON during on-board diagnostic.	DTC set during on-board diagnostic—rerun with A/C OFF. Failed ON—EPC pressure slightly low with A/C OFF.	Refer to PC/ED ¹
P0781**	SSA/SS1 or internal parts	1-2 shift error	Engine rpm drop not detected when 1-2 shift was commanded by PCM.	Improper gear selection depending on failure or mode and manual lever position. Shift errors may also be due to other internal transmission concerns (stuck valves, damaged friction material).	Refer to Solenoid Operation Charts. Refer to Pinpoint Test A .
P0782**	SSA/SS1, SSB/SS2 or internal parts	2-3 shift error	Engine rpm drop not detected when 2-3 shift	Improper gear selection depending on failure or mode and manual lever position. Shift errors may also be due to other	Refer to Solenoid Operation

			was commanded by PCM.	internal transmission concerns (stuck valves, damaged friction material).	Charts. Refer to Pinpoint Test A .
P0783**	SSA/SS1, SSB/SS2 or internal parts	3-4 shift error	Engine rpm drop not detected when 3-4 shift was commanded by PCM.	Improper gear selection depending on failure or mode and manual lever position. Shift errors may also be due to other internal transmission concerns (stuck valves, damaged friction material).	Refer to Solenoid Operation Charts. Refer to Pinpoint Test A .
P0750*	SSA/SS1, Wiring, PCM	SSA/SS1 solenoid circuit failure	SSA/SS1 circuit failed to provide voltage drop across solenoid. Circuit open or shorted or PCM driver failure during on-board diagnostic.	Improper gear selection depending on condition mode and manual lever position. See Solenoid Operation chart.	Refer to Pinpoint Test A .
P0755*	SSB/SS2, Wiring, PCM	SSB/SS2 solenoid circuit failure	SSB/SS2 circuit fails to provide voltage drop across solenoid. Circuit open or shorted or PCM driver failure during on-board diagnostic.	Improper gear selection depending on condition mode and manual lever position. See Solenoid Operation chart.	Refer to Pinpoint Test A .
—	TCIL	TCIL circuit failure	TCIL circuit open or shorted.	Failed ON—Overdrive cancel mode on. NO flashing TCIL for EPC failure or sensor. Failed OFF—Overdrive cancel mode never indicated. NO flashing TCIL for EPC sensor failure.	Refer to PC/ED ¹
P1747*	EPC, Wiring, PCM	EPC solenoid circuit failure, shorted circuit or output driver.	Voltage through EPC solenoid is checked. An error will be noted if tolerance is exceeded.	Short Circuit—Causes minimum EPC pressure (minimum capacity) and limits engine torque (alternate firm).	Refer to Pinpoint Test E .
P1746*	EPC, Wiring, PCM	Shorted PCM output driver.	Voltage through EPC solenoid is checked. An error will be noted if tolerance is exceeded.	Open Circuit—Causes maximum EPC pressure, harsh engagements and shifts.	Refer to Pinpoint Test E .
P0741**	TCC, Internal Components	TCC slippage detected.	The PCM picked up an excessive amount of slippage during normal vehicle operation.	Transmission slippage/erratic or no torque converter clutch operation. Flash TCIL.	Refer to Diagnosis by Symptom.
P1780	TCS	TCS not changing states.	TCS not cycled during self-test. TCS circuit open or shorted.	Rerun on-board diagnostic and cycle switch. No OD cancel when switch is cycled.	Refer to PC/ED ¹
P1711	TFT	TFT out of on-board diagnostic range.	Transmission not at operating temperature during on-board diagnostic.	Warm vehicle to normal operating temperature.	Refer to Pinpoint Test B .
P0713	TFT, Wiring, PCM	-40°C (-40°F) indicated TFT sensor circuit open.	Voltage drop across TFT sensor exceeds scale set for temperature -40°C (-40°F)	Firm shift feel.	Refer to Pinpoint Test B .
P0712	TFT	157°C (315°F) indicated TFT sensor circuit grounded.	Voltage drop across TFT sensor exceeds scale set for temperature of 157°C (315°F)	Firm shift feel.	Refer to Pinpoint Test B .
P0720	OSS	Insufficient input from output shaft speed sensor.	PCM detected a loss of OSS signal during operation.	Harsh shifts, abnormal shift schedule, no torque converter clutch activation.	Refer to Pinpoint Test E .

P0743*	TCC, Wiring, PCM	TCC solenoid circuit failure during on-board diagnostic.	TCC solenoid circuit fails to provide voltage drop across solenoid. Circuit open or shorted or PCM drive failure during on-board diagnostic.	Short circuit—Engine stalls in second (OD, 2 range) at low idle speeds with brake applied. Open circuit—Torque converter clutch never engages.	Refer to Pinpoint Test A .
P1705	Digital TR	Digital TR not in PARK or NEUTRAL.	On-board diagnostic not run in PARK.	Rerun on-board diagnostic in PARK.	Refer to Pinpoint Test D .
P1704	Digital TR	Digital TR sensor failure in transition state.	DTR sensor misaligned or failed electrically.	Increase in EPC pressure.	Refer to Pinpoint Test D .
P1741**	TCC, Internal Components	Excessive torque converter clutch engagement error.	Excessive variations in slip (engine speed surge) across the torque converter clutch.	Engine RPM oscillation is present in 3rd gear.	Refer to Pinpoint Test A .
P1783	TFT	Transmission overtemp condition indicated.	Transmission fluid temperature exceeded 127°C 70°F).	Increase in EPC pressure.	Refer to Pinpoint Test B .
P0705	Digital TR Sensor, Wiring, PCM	Digital TR circuit failure.	Digital TR sensor, circuit or PCM shorted or grounded.	Increase in EPC pressure.	Refer to Pinpoint Test D .
P0708	Digital TR Sensor, Wiring, PCM	Digital TR circuit above maximum voltage — open.	Digital TR sensor, circuit or PCM indicates open.	Increase in EPC pressure.	Refer to Pinpoint Test D .
P0751	SSA/SS1	Shift solenoid No. 1 functional failure.	Mechanical or hydraulic failure of the shift solenoid.	Improper gear selection depending on failure mode and manual lever position.	Refer to Solenoid Operation Chart. Refer to Pinpoint Test A .
P0756	SSB/SS2	Shift solenoid No. 2 functional failure.	Mechanical or hydraulic failure of the shift solenoid.	Improper gear selection depending on failure mode and manual lever position.	Refer to Solenoid Operation Chart. Refer to Pinpoint Test A .
P1742	TCC, Internal Parts	TCC solenoid failed ON (California only).	TCC solenoid has failed ON by electric, mechanical or hydraulic concern.	Harsh shifts.	Refer to Pinpoint Test A .
P1743	TCC, Internal Parts	TCC solenoid failed ON.	TCC solenoid has failed ON by electric, mechanical or hydraulic concern.	Harsh shifts.	Refer to Pinpoint Test A .
P1744	Transmission (California only)	Transmission slippage detected.	The PCM picked up an excessive amount of slippage during normal vehicle operation.	Transmission slippage/erratic or no torque converter clutch operation.	Refer to Diagnosis by Symptom.
P1751**	SSA/SS1	Shift solenoid No. 1 functional failure (California only)	Mechanical or hydraulic failure of the shift solenoid.	Improper gear selection depending on failure mode and manual lever position.	Refer to Solenoid Operation Chart. Refer to Pinpoint Test A .
P1756**	SSB/SS2	Shift solenoid No. 2 functional	Mechanical or hydraulic failure of the shift solenoid.	Improper gear selection depending on failure mode and manual lever position.	Refer to Solenoid Operation

		failure (California only)			Chart. Refer to Pinpoint Test A.
P1714	SSA/SS1	SSA/SS1 malfunction.	Mechanical failure of the solenoid detected.	Improper gear selection depending on condition, mode and manual lever position. See Solenoid Operation Chart.	Refer to Pinpoint Test H.
P1715	SSB/SS2	SSB/SS2 malfunction.	Mechanical failure of the solenoid detected.	Improper gear selection depending on condition, mode and manual lever position. See Solenoid Operation Chart.	Refer to Pinpoint Test H
P1728	Trans	Transmission slippage detected.	The PCM has detected an excessive amount of slippage during normal operation.	Transmission slippage/erratic or no torque clutch operation.	Diagnosis by Symptom Chart.
P1767	TCC	TCC solenoid circuit failure during OBD Test.	TCC Solenoid circuit fails to provide voltage drop across solenoid. Circuit open or shorted or PCM Driver failure during OBD test.	Short circuit: engine stalls in second (O/D, 2 range) at low idle speeds with brake applied. Open circuit: torque converter never engages.	Refer to Pinpoint Test A.
P1740	TCC	TCC malfunction.	Mechanical failure of the solenoid detected.	Failed ON - engine stalls in 2nd (O/D, Manual 2 ranges) at low idle speeds with brake applied. Failed OFF - torque converter never applies.	Refer to Pinpoint Test H.
P0721	OSS	Output Shaft Speed Sensor signal noisy.	PCM has detected an erratic OSS signal.	Harsh shifts, abnormal shift schedule, no torque converter clutch engagement.	Refer to Pinpoint Test E.
P1710	TFT	TFT in range failure.	PCM detected no change in TFT during operation.	Firm shifts, increase in EPC, TCIL flashing.	Refer to Pinpoint Test B.

¹ Can be purchased as a separate item.

1. PC/ED—Powertrain Control/Emissions Diagnosis Manual¹.

Rotunda Transmission Tester

Use Rotunda Transmission Tester 007-00130 and Rotunda Transmission Range (TR) Sensor Cable "E" 418-F107 (007-00111) with Digital (TR) Sensor Overlay 007-00131 or equivalent to diagnose electronically controlled transmissions. The following instructions outline the set-up and use of this tester in the pinpoint tests for the 4R70W.

Overlays and Adapters

The following transmission tester overlays and adapters must be used with the Rotunda Transmission Tester 007-00130 or equivalent to properly diagnose the 4R70W transmission.

- Rotunda Transmission Range (TR) Sensor Cable "E" and Digital TR Sensor Overlay (007-00131) or equivalent.

Tester Jacks

1. **VPWR Pin Jacks (red):** VPWR test points for solenoid circuits.
2. **Solenoid (MCCC, EPC) Signal Line Pin Jacks (black):** Signal line test points for solenoid circuits.

NOTE: The tester overlay is labeled for the MCCC solenoid. This is used to test the torque converter clutch (TCC) solenoid.

3. **BAT+ (red) and BAT- (black) Pin Jacks:** Battery reference points when measuring circuits for shorts.
4. **TOT Pin Jacks:** Test points for transmission fluid temperature sensor (TFT sensor).
5. **OSS Pin Jacks:** Test points for output speed shaft sensor (OSS).

LEDs and Controls

1. **Cable Correctly Installed LEDs:** When LED is lit, the cable is installed correctly.
2. **Status LEDs:** LED OFF when not activated by tester (solenoid not activated, open circuit or signal line short to ground). LED green when activated by tester and current draw is correct. LED red when activated by tester and current draw is excessive (short to battery positive voltage (B+)). All LEDs light orange during self-test.
3. **Solenoid Activate Buttons:** Energize respective solenoids during click testing and activate selected circuits during DRIVE mode testing.
4. **Bench/Drive Switch:** Selects operating mode, either BENCH or DRIVE.
5. **Solenoid Select/Gear Select Switch:** Has three functions. In BENCH MODE: acts as shift solenoid selector for click testing. In DRIVE MODE: acts as forward gear selector in place of vehicle's PCM-controlled shifting. Hydraulic safety mechanisms and overrides are built in to the transmission. In OHMS CHECK: allows you to measure resistance (ohms).

Digital Transmission Range (TR) Sensor Testing

Introduction

The Transmission Tester and TR Testing Cable "E" 418-F107 (007-00111) or equivalent with Digital TR Sensor Overlay 007-00131 or equivalent allows a technician to test the digital TR sensor independent of vehicle electronics. Digital TR sensor testing is divided into four steps:

1. Preliminary diagnosis and testing.
2. Installing the Transmission Tester and TR Testing Cable "E" 418-F107 (007-00111) with Digital TR Sensor Overlay 007-00131 or equivalent.
3. Testing the digital transmission range (TR) sensor.
4. Testing the park/neutral, backup and optional circuits.

Preliminary Testing and Diagnosis

Before any diagnostic testing is done on a vehicle some preliminary checks must be performed. Be sure to write down any findings, especially any DTCs, for future reference.

1. Know and understand customer's concern.
2. Verify that digital TR sensor is properly adjusted in NEUTRAL.
3. Verify customer concern:
 - Upshift
 - Downshift
 - Coasting
 - Engagement

If concern involves noise or vibration, does it relate to any of the following?

- Rpm
 - Vehicle speed
 - Shift
 - Gear
 - Range
 - Temperature
4. Vehicle must be at normal operating temperature.
 5. Check transmission fluid level and condition.
 6. Check for the following items:
 - Vehicle modifications
 - Electronic add-on items
 - Leaks
 - Linkage adjustments
 7. Check TSBs and OASIS for related information.

8. Perform complete On-Board Diagnostics (OBD) for both KOEO and KOER.

9. Record all DTCs.

10. Repair all non-transmission DTCs.

Installation Procedures

Installing the Transmission Tester and TR Testing Cable "E" 418-F107 (007-00111) or equivalent with Digital TR Sensor Overlay 007-00131 or equivalent at the transmission connector allows separation of the digital TR sensor electronics from the vehicle electronics.

Testing may cause additional fault codes to be set. Therefore, it is important that all DTCs are erased whenever repairs are made. To verify elimination of all codes, rerun OBD test.

The following manuals will assist in diagnosis of electronically controlled transmissions:

- Powertrain Control/Emissions Diagnosis Manual.
- Transmission Reference Manual.

1. For proper Digital TR Sensor Diagnosis follow Pinpoint Test D.

2. Disconnect vehicle harness at digital transmission TR sensor.

3. Set the two-way switch in the down position. (This switch will stay in the same position for all digital TR sensor testing.)

4. Attach the Digital TR sensor overlay 007-00131 or equivalent to the transmission tester.

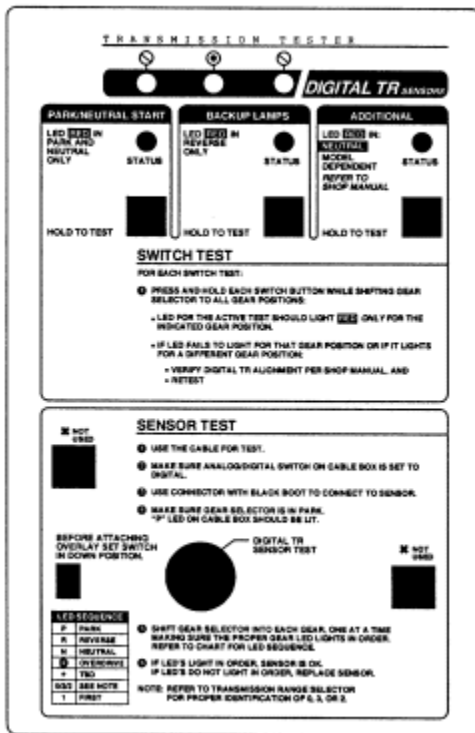

AD0295-A

Affixing the overlay will immobilize the two-way switch (set in Step 2) so it cannot be accidentally moved to an incorrect setting during testing.

5. Select and connect interface cable "E" 418-F107 (007-00111) or equivalent to the tester and then black connector (Digital) to TR sensor.



GD3303-A

6. Set Analog/Digital Switch on TR-E Cable to Digital.

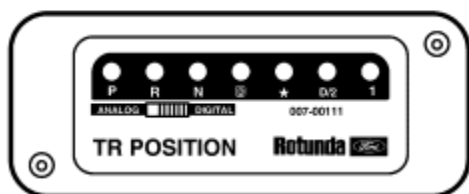

AD0266-A



CAUTION: Route all cables away from heat sources to prevent damage to cables during testing.

Use the transmission tester extender cable when running tests with the transmission on the vehicle.

7. Turn large dial to DIGITAL TR SENSOR TEST.

SENSOR TEST

NOT USED [X] []

- 1 USE TR-E CABLE FOR TEST.
- 2 MAKE SURE ANALOG/DIGITAL SWITCH ON CABLE BOX IS SET TO DIGITAL.
- 3 USE CONNECTOR WITH BLACK BOOT TO CONNECT TO SENSOR.
- 4 MAKE SURE GEAR SELECTOR IS IN PARK. *1st LED ON CABLE BOX SHOULD BE LIT.

BEFORE ATTACHING OVERLAP SET SWITCH IN DOWN POSITION.

LED SEQUENCE

P	IMPR
R	REVERSE
N	NEUTRAL
D	DRIVE/REV
*	TRD
D2	SEE NOTE
1	RESET

DIGITAL TR SENSOR TEST

NOT USED [X] []

- 5 SHIFT GEAR SELECTOR INTO EACH GEAR, ONE AT A TIME MAKING SURE THE PROPER GEAR LED LIGHTS IN ORDER. REFER TO CHART FOR LED SEQUENCE.
- 6 IF LED'S LIGHT IN ORDER, SENSOR IS OK. IF LED'S DO NOT LIGHT IN ORDER, REPLACE SENSOR.

NOTE: REFER TO TRANSMISSION RANGE SELECTOR FOR PROPER IDENTIFICATION OF D, S, OR 2.

PART No. 1102109

GD3146-A

8.  **CAUTION:** For resistance checks, be sure that the tester selector switch is set to the TR SENSOR TEST position or damage to the ohmmeter may result.

Plug transmission tester power cable into cigar lighter socket.

All LEDs should light for a short period and then turn off. This is the Tester's internal circuit check.

Sensor Test

 **CAUTION:** Be sure that the DIGITAL 12 pin sensor cable connector (black) is used. If the wrong connection is made or the slide switch is in the wrong position, the LEDs on the TR cable will give false or no response during testing. This will cause the replacement of good parts.

1. Place transmission range selector lever into PARK.
2. Make sure that the "E" cable ANALOG/DIGITAL switch is set to DIGITAL.
3. Move the transmission range selector lever through all ranges.
4. Monitor the LEDs, located on the "E" cable, in each gear position. The LED should illuminate RED for the appropriate range selected.
5. If the LED for the applicable gear range position fails to illuminate RED or if it lights for a position other than the gear selected:
 - Verify test cable connections at sensor and tester.
 - Verify transmission shift linkage for proper adjustment.
 - Verify digital TR sensor for proper adjustment.
 - Retest.
6. If the sensor still fails to illuminate the LED RED for the selected gear range or indicates incorrect gear position, replace it.

Switch Tests — Park/Neutral, Backup Lamp and Optional Circuits

NOTE: LED lights red when circuit is closed.

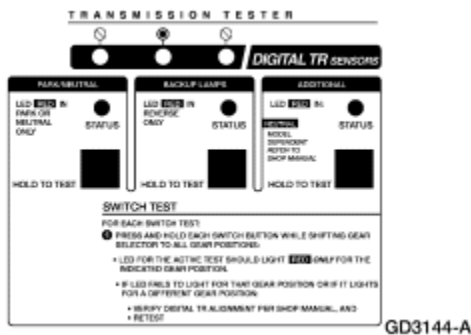

LED turns off when circuit is open.

1. Press and hold each test button while moving the transmission range selector lever to each gear position.
2. Monitor each STATUS LED:

The LED in the appropriate gear position being testing should light red.

If the LED for the applicable gear position fails to light red, or if it lights for a position other than the gear selected:

- Verify digital TR alignment. Refer to the assembly procedure in this section.
 - Retest.
3. If the digital TR sensor fails, replace it.

After testing is finished, follow the Disconnecting The Tester procedure in this section.

Disconnecting The Tester

1.  **CAUTION: Do not attempt to pry off connectors with a screwdriver. This will damage the connector and could result in a transmission concern.**

Disconnect transmission tester from the digital TR sensor connector.

2. Reinstall vehicle wiring harness. Verify connection by pulling up on the harness.
3. Reinstall all heat shields that were previously removed.
4. Disconnect transmission tester power lead from vehicle.
5. Erase all DTCs using the procedures in the Powertrain Control/Emissions Diagnosis Manual .
6. Rerun On-Board Diagnostic Tests to receive a pass code.
7. Verify that the customer concern has been eliminated.

Transmission Connector Layouts

Refer to Electrical and Vacuum Troubleshooting Manual, Cell [29](#), Transmission Control, for schematic and connector information.

Transmission Internal Harness

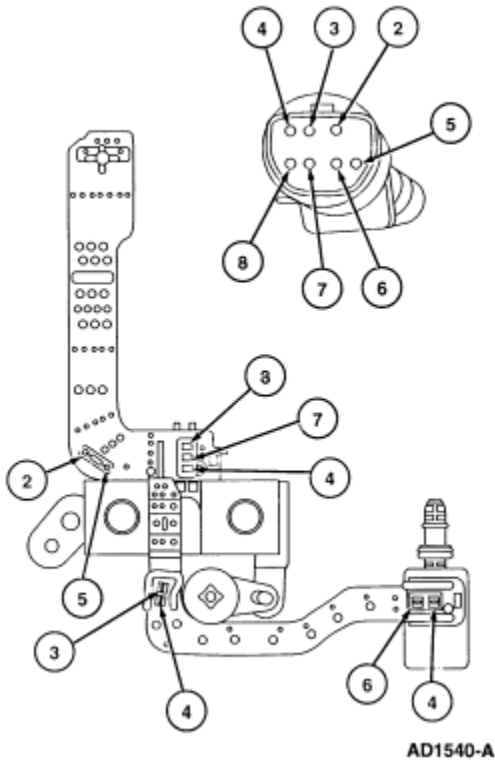

Item	Part Number	Description
1	—	NOT USED
2	—	TFT Return
3	—	TCC
4	—	SS VPWR
5	—	TFT
6	—	EPC Solenoid

7	—	SSA/SS1
8	—	SSB/SS2
9	—	NOT USED
10	—	NOT USED

Digital Transmission Range (TR) Sensor Connector (C110)

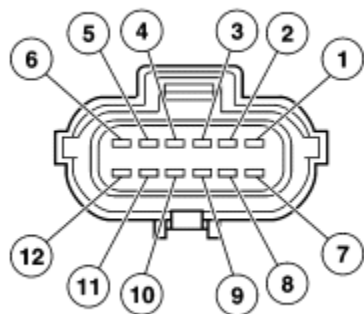

GD1565-A

Pin Number	Circuit	EEC-V Pin Number	Circuit Function
1	—	—	NOT USED
2	359 (GY/R)	91	Signal Return
3	199 (LB/Y)	64	TR3A
4	1144 (Y/BK)	3	TR1
5	1145 (LB/BK)	49	TR2
6	1143 (W/BK)	50	TR4
7	57 (BK)	—	Ground
8	463 (R/W)	—	Neutral Sense
9	298 (P/O)	—	Fused Power Feed
10	32 (R/LB)	—	Starter Control
11	140 (BK/PK)	—	Back Up
12	33 (W/PK) 329 (PK)	—	Starter to Starter Interrupt Relay

Transmission Harness Connector (C132)

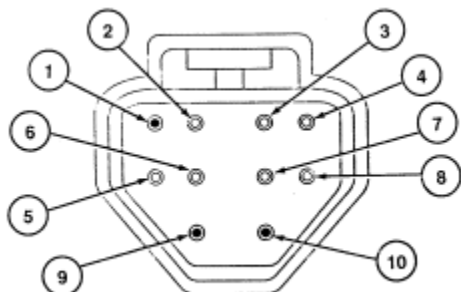

AD1541-A

Pin Number	Circuit	Circuit Function
1	—	NOT USED
2	359 (GY/R)	Signal Return
3	126 (P/Y)	Torque Converter Clutch (TCC) Solenoid
4	361 (R)	Vehicle Power
5	923 (O/BK)	Transmission Fluid Temperature (TFT) Input
6	925 (W/Y)	Electronic Pressure Control (EPC) Solenoid
7	237 (O/Y)	Shift Solenoid No. 1
8	315 (P/O)	Shift Solenoid No. 2
9	—	NOT USED
10	—	NOT USED

Output Shaft Speed Sensor Connector (C1058)

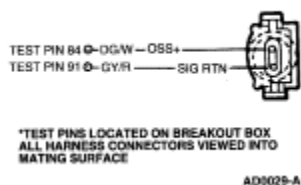

Pinpoint Test A—Shift Solenoids

REFERENCE: SOLENOID OPERATION CHART #701

Transmission Range Selector Lever Position	PCM Commanded Gear	Solenoids		
		SSA/ SS1	SSB/ SS2	TCC
P/R/N	1	ON	OFF	HD
D	1	ON	OFF	HD
D	2	OFF	OFF	EC
D	3	OFF	ON	EC
D	4	ON	ON	EC
D w/OD OFF				
1	1	ON	OFF	HD
2	2	OFF	OFF	EC
3	3	OFF	ON	EC
Manual 2	2	OFF	OFF	EC
Manual 1	1	ON	OFF	HD
1 ^a	2	OFF	OFF	EC

^a When a manual pull-in occurs above a calibrated speed the transmission will downshift from the higher gear until the vehicle speed drops below this calibrated speed.

EC = Electronically Controlled

HD = Hydraulically Disabled

Shift Solenoid Failure Modes "Always On"

Shift Solenoid Failure

Failed ON due to powertrain control module and/or vehicle wiring concerns, shift solenoid (7G484) electrically or hydraulically stuck ON.

SSA/SS1 ALWAYS ON:	Transmission Range Selector Lever Position		
	(D)	2	1
PCM Gear Commanded	Actual Gear Obtained		
1	1	1	1
2	1	1	1
3	4	2 ^a	2 ^a
4	4	2 ^a	2 ^a

^a No Engine Braking

SSB/SS2 ALWAYS ON:	Transmission Range Selector Lever Position		
	(D)	2	1
PCM Gear Commanded	Actual Gear Obtained		
1	4	2 ^a	2 ^a
2	3	2 ^a	2 ^a
3	3	2 ^a	2 ^a
4	4	2 ^a	2 ^a

^a No Engine Braking

Shift Solenoid Failure Mode "Always Off"

Failed OFF due to powertrain control module and/or vehicle wiring concerns, shift solenoid electrically or hydraulically stuck OFF.

SSA/SS1 ALWAYS OFF:	Transmission Range Selector Lever Position		
	(D)	2	1
PCM Gear Commanded	Actual Gear Obtained		
1	2	2	2
2	2	2	2
3	3	2 ^a	2 ^a
4	3	2 ^a	2 ^a

^a No Engine Braking

SSB/SS2 ALWAYS OFF:	Transmission Range Selector Lever Position		
	(D)	2	1
PCM Gear Commanded	Actual Gear Obtained		
1	1	1	1
2	2	2	2

3	2	2	2
4	1	1	1

PINPOINT TEST A: SHIFT SOLENOIDS (SSA/SS1, SSB/SS2) AND TORQUE CONVERTER CLUTCH (TCC) SOLENOID

NOTE: Refer to the Transmission Internal Harness Illustration preceding these pinpoint tests.

NOTE: Refer to the Transmission Harness Connector Illustration preceding these pinpoint tests.

NOTE: Read and record all DTCs. All digital TR Sensor and VSS DTCs must be repaired before entering Output State Control (OSC).

A1 ELECTRONIC DIAGNOSTICS

- Turn ignition switch OFF.
- Place transmission range selector lever in park.
- Check to make sure the transmission harness connector C132 is fully seated, terminals are fully engaged in connector and in good condition before proceeding.
- Connect New Generation STAR (NGS) Tester 418-F048 (007-00500) or equivalent.
- Turn ignition switch to ON position.
- Select Diagnostic Data Link.
- Select PCM.
- Select Active Command Modes.
- Select Output State Control (OSC).
- Select Trans-Bench Mode.

Does vehicle enter Trans-Bench Mode?

Yes	No
REMAIN in Trans-Bench Mode. GO to A2 .	REPEAT procedure to enter Trans-Bench Mode. If vehicle did not enter Trans-Bench Mode, REFER to Powertrain Control/Emissions Diagnosis Manual for diagnosis of PCM or NGS.

A2 WIGGLE TEST

- Remain on Trans-Bench Mode.
- Select PIDs to be monitored.

PID Command	PID Actual
SSA	SS1F
SSB	SS2F
TCC	TCCF

- Trigger "ON" to turn suspect solenoid on.
- Press "SEND".
- Wiggle all wiring and connectors to the transmission. Monitor the Solenoid State for changes.
- Trigger "OFF" to turn solenoid off.
- Press "SEND".

Does the suspect solenoid(s) state change?

Yes	No
REPAIR open or short in the vehicle harness or connector.	GO to A3 .

A3 SOLENOID FUNCTIONAL CHECK

- Monitor each solenoid state.
- Turn each solenoid ON and OFF.

Does the solenoid turn ON and OFF when commanded and can solenoid activation be heard?

Yes	No
GO to A4 .	GO to A5 .

A4 OSC TRANS-DRIVE MODE (GR_CM OR TCC)

- Perform OSC Trans-Drive Mode.
- Select GR_CM for Shift Solenoids or follow drive mode procedures for GR_CM as listed in this section.
- Select TCC for Torque Converter Clutch Solenoid. Follow Drive Mode procedures of TCC in as listed in this section.

Does the transmission upshift and downshift or torque converter engage/disengage when commanded?

Yes	No
CLEAR all DTCs. Road test to verify if concern is still present. If concern is still present, REFER to Diagnosis by Symptom to diagnose shift or torque converter concern.	GO to A5 .

A5 CHECK FOR VOLTAGE

- Remove transmission fluid pan.
- Visually inspect the lead frame and connectors for damage.
- Turn ignition switch ON.
- Connect DVOM positive lead to VPWR solenoid terminal Pin 4 and negative lead to a good ground.

Is the battery voltage present?

Yes	No
GO to A6 .	CHECK for open or short circuit in harness, or solenoid.

A6 ELECTRICAL SIGNAL CHECK

- Leave positive lead connected to VPWR solenoid terminal Pin 4 and connect negative lead to the signal terminal of the appropriate solenoid.
- Select Trans-Bench Mode.
- Select Command SSA/SS1, SSB/SS2 or TCC.
- Press trigger to select "ON".
- Press "SEND".
- Turn each solenoid ON and OFF, while monitoring the voltage reading on the DVOM, solenoid state on the NGS (ON and OFF), listen for the solenoid to activate (click).
- Press trigger to select "OFF".
- Press "SEND".

Does the voltage and solenoid state for each change?

Yes	No
GO to A7 .	CHECK for open or short circuit in harness, solenoid or a PCM concern.

A7 CHECK SOLENOID RESISTANCE AT SOLENOID

- Disconnect the appropriate solenoid from the lead frame.

- Connect voltmeter to each solenoid measure the resistance.
- Measure and record the resistance for each solenoid (SSA/SS1, SSB/SS2 or TCC).

Solenoid	Resistance (ohms)
SSA/SS1	20-30
SSB/SS2	20-30
TCC	10-16

Is the resistance within specification?

Yes	No
GO to A8 .	REPLACE the solenoid.

A8 CHECK SOLENOID FOR SHORT TO GROUND

- Check for continuity between engine ground and appropriate solenoid terminal with ohmmeter or other low current tester (less than 200 milliamps). Connection should show infinite resistance (no continuity).

Solenoid	Terminal
SSA/SS1	±/-
SSB/SS2	±/-
TCC	±/-

Is there continuity?

Yes	No
REPLACE the solenoid.	REFER to Diagnosis by Symptom Index for diagnosis of shift or torque converter concerns.

PINPOINT TEST B: TRANSMISSION FLUID TEMPERATURE (TFT) SENSOR

NOTE: Refer to the Transmission Internal Harness Illustration preceding these pinpoint tests.

NOTE: Refer to the Transmission Harness Connector Illustration preceding these pinpoint tests.

B1 ELECTRONIC DIAGNOSTICS

- Check to make sure the transmission harness connector is fully seated, terminals are fully engaged in connector C132 and in good condition before proceeding.
- Connect New Generation STAR (NGS) Tester 418-F048 (007-00500) or equivalent.
- Select Diagnostic Data Link.
- Select PCM.
- Select PID/Data Monitor and Record.
- Select Tran 3 priority.
- Select PIDs; TFT, TFTV.

Does the vehicle enter PID/Data Monitor and Record?

Yes	No
REMAIN in PID/Data Control. GO to B2 .	REPEAT procedure to enter PID. If vehicle did not enter PID, REFER to Powertrain Control/Emissions Diagnosis

B2 WARM-UP/COOL-DOWN CYCLE

- While monitoring the TFT PIDs, perform the following test: If transmission is cold, run transmission to warm it up. If transmission is warm, allow transmission to cool down.

Do the TFT PIDs increase as the transmission is warmed up or decrease as the transmission is cooled or does the TFT or TFTV drop in and out of range?

Yes	No
<p>If the TFT PIDs increase as the transmission is warmed or decrease as the transmission is cooled, CLEAR all DTCs. Road test to verify if concern is still present. If concern is still present, REFER to Diagnosis by Symptom to diagnose transmission overheating.</p> <p>If the TFT or TFTV drop in and out of range, INSPECT for intermittent concern in the internal/external harness, sensor or connector.</p>	<p>GO to B3 .</p>

B3 ELECTRICAL SIGNAL CHECK

- Remove transmission fluid pan.
- Visually inspect the lead frame and connectors for damage.
- Connect DVOM positive lead to Pin 2 +TFT at sensor terminal and negative lead to a good ground.

Is the voltage present?

Yes	No
<p>GO to B4 .</p>	<p>CHECK for open or short circuit in vehicle harness, internal harness or a PCM concern.</p>

B4 CHECK RESISTANCE OF TFT SENSOR

- Disconnect Transmission Harness connector C132 .
- Connect DVOM across Pin 2 +TFT and Pin 5 -TFT terminals at transmission connector C132 .
- Record the resistance.
- Resistance should be approximately in the following ranges:

Transmission Fluid Temperature

°C	°F	Resistance (Ohms)
-40 to -20	-40 to -4	967K - 284K
-19 to -1	-3 - 31	284K - 100K
0 - 20	32 - 68	100K - 37K
21 - 40	69 - 104	37K - 16K
41 - 70	105 - 158	16K - 5K
71 - 90	159 - 194	5K - 2.7K
91 - 110	195 - 230	2.7K - 1.5K
111 - 130	231 - 266	1.5K - 0.8K
131 - 150	267 - 302	0.8K - 0.54K

Is the resistance in the range?

Yes	No
REFER to Diagnosis by Symptom Index to diagnose an overheating concern.	REPLACE internal harness (sensor is part of harness).

Pinpoint Test C

Test does not apply.

Pinpoint Test D: Digital Transmission (TR) Sensor

Digital TR Sensor Overlay 007-00131

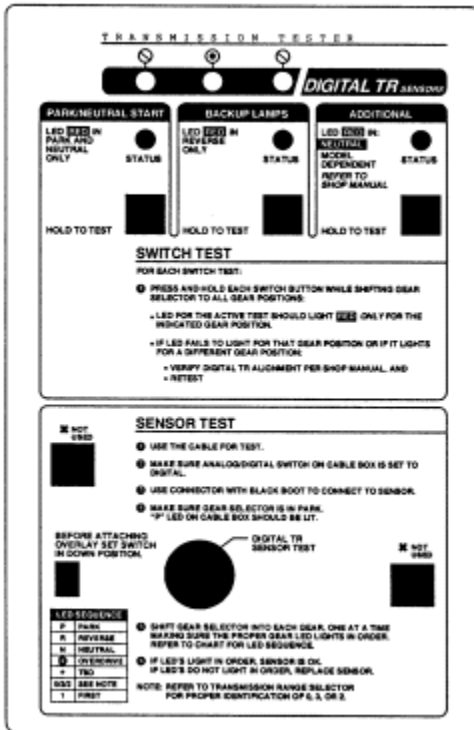

AD0295-A

Digital TR Sensor Adapter Cable 418-F107 (007-00111) TR Position Display

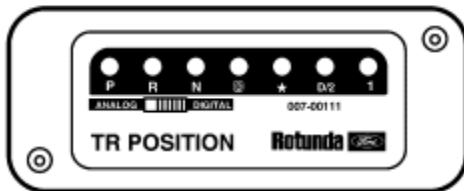

AD0266-A

PINPOINT TEST D: DIGITAL TRANSMISSION RANGE (TR) SENSOR

NOTE: Refer to the Digital Transmission Range (TR) Sensor Connector illustration preceding these pinpoint tests.

D1 CHECK THE TRANSMISSION RANGE (TR) SENSOR ALIGNMENT

- Turn ignition switch OFF.
- Place transmission range selector lever in PARK.
- Check to make sure the digital (TR) sensor harness connector C110 is fully seated, terminals are fully engaged in connector and in good condition before proceeding.
- Apply the parking brake.
- Place transmission range selector lever in NEUTRAL.
- Check the shift linkage adjustment with the transmission range selector lever in the drive (D) position.
- Place transmission range selector lever in DRIVE.
- Check that the Digital Transmission Range Sensor Alignment Tool fits in the appropriate slots.

Is the digital transmission range sensor properly adjusted?

Yes	No
GO to D2 .	ADJUST the digital transmission range sensor; refer to the Digital Transmission Range (TR) Sensor procedure in this section. PLACE transmission range selector lever in park (P) and clear the DTCs. RERUN OBD Test.

D2 CHECK ELECTRICAL SIGNAL OPERATION

- Place transmission selector lever in PARK.
- Disconnect Digital (TR) Connector C110 .



CAUTION: Do not pry on connector. This will damage the connector and result in a transmission concern. Press button and pull out on digital (TR) harness connector.

- Inspect both ends of the connector for damage or pushed out pins, corrosion, loose wires and missing or damaged seals.

Is there damage to the connector, pins or harness?

Yes	No
REPAIR as required. CLEAR DTCs and RERUN OBD Tests.	If diagnosing a DTC, GO to D3 . If diagnosing a starting concern, a backup lamp concern, or engagement concern, GO to D8 .

D3 CHECK ELECTRICAL SYSTEM OPERATION (DTR AND PCM)

- Turn ignition switch to the OFF position.
- Connect New Generation STAR (NGS) Tester.
- Enter transmission priority.
- Select TR PIDS TR, TR_D.
- Connect DTR Sensor Connector.
- Move transmission range selector lever into each gear and stop.
- Observe the PIDs, TR and TR_D, while wiggling harness and tapping on sensor.
- Compare the PIDs to the chart below:

Selector Position	TR	TR_D
Park	P/N	0000
Reverse	REV	1100
Neutral	NTRL	0110
Drive	O/D*	1111
Man 2	MAN2	1001

Man 1	MAN1	0011
-------	------	------

* Will read "DRIVE" if O/D cancel switch is "ON".

Do the PIDs TR and TR_D match the above chart and does the TR_D PID remain steady when the harness is wiggled or when the sensor is tapped upon?

Yes	No
The problem is not in the digital TR sensor system. REFER to Diagnosis by Symptom for further diagnosis.	GO to D4 . If TR_D changes when wiggling harness or tapping on the sensor, problem may be intermittent.

D4 CHECK THE INTERNAL CIRCUITS OF THE TRANSMISSION RANGE (TR) SENSOR

- Disconnect Transmission Range Sensor Connector C110 .
- Connect Transmission Range Sensor Tester Cable TR-E (418-F107 (007-00111)) or equivalent to the transmission tester (007-00130).
- Connect the tester cable "E" to the digital transmission range (TR) sensor.
- Place the Digital TR Overlay (007-00131) on the transmission tester.
- Perform the SENSOR TEST as instructed on the Digital TR Overlay.

Does the status lamp on the tester TR-E cable match the selected gear positions?

Yes	No
Concern is not in the digital transmission range sensor, GO to D5 .	REPLACE the digital transmission range sensor and adjust. REFER to the Digital Transmission Range (TR) Sensor procedures. CLEAR DTCs and RERUN OBD Tests.

D5 CHECK CIRCUITS TO PCM FOR OPENS

- Turn ignition switch OFF.
- Disconnect Powertrain Control Module Connector C291 and Inspect for damaged or pushed out pins, corrosion or loose wires.



CAUTION: Do not pry connector. This will damage the connector and result in a transmission concern.

- Press button and disconnect Digital Transmission Range (TR) Sensor harness connector C110 .
- Install Rotunda 104-Pin breakout box (418-049 (014-00950)) or equivalent to C291 .
- Measure the resistance between the breakout box Pin 91 and the Digital transmission range sensor connector Pin C110 .
- Measure the resistance between the breakout box Pin 3 and the Digital transmission range selector connector Pin C110 .
- Measure the resistance between the breakout box Pin 49 and the Digital transmission range sensor connector Pin C110 .
- Measure the resistance between the breakout box Pin 50 and the Digital transmission range sensor connector Pin C110 .
- Measure the resistance between the breakout box Pin 64 and the Digital transmission range sensor connector Pin C110 .

Is each resistance less than 5 ohms?

Yes	No
GO to D6 .	SERVICE the open circuit(s). RECONNECT the components. RETEST the system. CLEAR DTCs and RERUN OBD Test.

D6 CHECK CIRCUITS FOR A SHORT TO GROUND OR TO POWER

- Measure the resistance between the breakout box Pin 91 and Pins 71/97.
- Measure the resistance between the breakout box Pin 64 and Pins 71/97 and 24/51/76/77/103 and 91.
- Measure the resistance between the breakout box Pin 3 and Pins 71/97 and 24/51/76/77/103 and 91.
- Measure the resistance between the breakout box Pin 49 and Pins 71/97 and 24/51/76/77/103 and 91.
- Measure the resistance between the breakout box Pin 50 and Pins 71/97 and 24/51/76/77/103 and 91.

Is each resistance more than 10,000 ohms?

Yes	No
GO to D7 .	SERVICE any circuits having less than 10,000 ohms resistance for a short to either power or ground. RECONNECT all the components. CLEAR the DTCs. RETEST the system.

D7 CHECK FOR A SHORT CIRCUIT BETWEEN THE TRANSMISSION RANGE (TR) SENSOR SIGNAL CIRCUITS

- Measure the resistance between the breakout box Pin 3 and the breakout box Pins 49, 50 and 64.
- Measure the resistance between the breakout box Pin 49 and the breakout box Pins 34, 50 and 64.
- Measure the resistance between the breakout box Pin 50 and the breakout box Pins 34, 49 and 64.
- Measure the resistance between the breakout box Pin 64 and the breakout box Pins 34, 49 and 50.

Is each resistance more than 10,000 ohms?

Yes	No
REPLACE the powertrain control module . RECONNECT all the components. RETEST the system.	SERVICE any circuits having less than 10,000 ohms resistance for a short to another transmission range (TR) sensor signal circuit. RECONNECT all the components. CLEAR the DTCs. RETEST the system.

D8 CHECK THE NON PCM INTERNAL CIRCUITS OF SENSOR

- Connect TR-E Cable (418-F107 (007-00111)) or equivalent to Transmission Tester (007-00130) or equivalent.
- Connect TR-E Cable (418-F107 (007-00111)) to Digital Transmission Range Sensor with BLACK marked "DIGITAL" to sensor.
- Place the DIGITAL TR Overlay onto Transmission Tester.
- Perform SWITCH Test as instructed on the digital TR overlay.

Does the status lamp on the tester indicate RED for the correct gear position?

Yes	No
Concern is not in the digital TR Sensor. For START SYSTEM concerns, GO to Section 03-06 . For backup lamp concerns, GO to Section 17-01 . For Optional Circuits: refer to the Powertrain Control/Emissions Diagnosis Manual .	REPLACE Digital (TR) Sensor and ADJUST. REFER to the Digital Transmission Range TR Sensor procedures. CLEAR DTCs and RERUN OBD Tests.

PINPOINT TEST E: ELECTRICAL PRESSURE CONTROL (EPC) SOLENOID

NOTE: Refer to the Transmission Internal Harness Illustration preceding these pinpoint tests.

NOTE: Refer to the Transmission Harness Connector Illustration preceding these pinpoint tests.

E1 ELECTRONIC DIAGNOSTICS

- Turn ignition switch to the OFF position.
- Place transmission range selector lever in the park position.
- Check to make sure the transmission harness connector C132 is fully seated, terminals are fully engaged in the connector and in good condition before proceeding.
- Connect New Generation STAR (NGS) Tester (007-00500) or equivalent.
- Turn the ignition switch to the RUN position.
- Select Diagnostic Data Link.
- Select PCM.
- Select Active Command Modes.
- Select Output State Control (OSC).
- Select Trans-Bench Mode.

Does the vehicle enter the Trans-Bench Mode?

Yes	No
REMAIN in Trans-Bench Mode. GO to E2 .	REPEAT procedure to ENTER Trans-Bench Mode. If vehicle did not enter OSC, REFER to Powertrain Control/Emissions Diagnosis Manual for diagnosis of PCM or NGS.

E2 SOLENOID FUNCTIONAL TEST

- Install 300 psi pressure gauge into EPC tap on transmission.
- Monitor pressure gauge.
- Select Command EPC Select value - 15, 30, 45, 60, 70 or 90 PSI.
- Press "SEND".
- Select another value "0-90 psi".
- Press "SEND".
- Monitor the solenoid state for changes.
- Press "SEND".

Does the pressure reading match the commanded pressure?

Yes	No
CLEAR DTCs.	GO to E3 .

E3 CHECK FOR BATTERY VOLTAGE

- Remove transmission fluid pan.
- Visually inspect the lead frame and connectors for damage.
- Turn the ignition switch to the RUN position.
- Connect DVOM positive lead to VPWR solenoid terminal Pin 4 and negative lead to a good ground.

Is the battery voltage present?

Yes	No
GO to E4 .	CHECK for open or short circuit in harness.

E4 ELECTRICAL SIGNAL CHECK

- Leave positive lead connected to VPWR solenoid terminal Pin 4 and connect negative lead to the signal terminal Pin 6 of the EPC solenoid.
- Turn the solenoids ON and OFF, while monitoring the voltage reading on the DVOM, solenoid state on the NGS (ON and OFF), listen for the solenoid to activate (click).
- Select Trans-Bench Mode.
- Select a value "0-90 psi".
- Press "SEND".
- Select another value "0-90 psi".
- Press "SEND".
- Monitor the solenoid state for changes.
- Press "SEND".

Does the voltage and solenoid state change?

Yes	No
GO to E5 .	CHECK for open or short circuit in harness or PCM.

E5 CHECK SOLENOID RESISTANCE AT SOLENOID

- Disconnect Transmission Harness connector C132 .
- Check solenoid resistance by connecting an ohmmeter at each terminals of the solenoid.
- Measure and record the resistance of the EPC solenoid. Resistance should be between 2.48-5.66 ohms.

Is the resistance within specification?

Yes	No
GO to E6 .	REPLACE the solenoid.

E6 CHECK SOLENOID FOR SHORT TO GROUND

- Check for continuity between engine GROUND and the EPC solenoid terminals with ohmmeter or other low current tester (less than 200 milliamps). Connection should show infinite resistance (no continuity).

Is there continuity?

Yes	No
REPLACE the solenoid.	REFER to Diagnosis by Symptom Index in this section for diagnosis of pressure concerns.

PINPOINT TEST F: OUTPUT SHAFT SPEED (OSS) SENSORS

NOTE: Refer to the Output Shaft Speed Sensor Connector Illustration preceding these pinpoint tests.

F1 ELECTRONIC DIAGNOSTICS

- Check to make sure the transmission harness connector is fully seated, terminals are fully engaged in connector and in good condition before proceeding.
- Connect New Generation STAR (NGS) Tester (007-00500) or equivalent.
- Turn the ignition switch to the RUN position.
- Select Diagnostic Data Link.
- Select PCM.
- Select PID/Data Monitor and Record.
- Select the following PID: OSS.

Does vehicle enter PID/Data Monitor and Record?

Yes	No
REMAIN in PID/Data. GO to F2 .	REPEAT procedure to ENTER PID. If vehicle did not enter PID, REFER to Powertrain Control/Emissions Diagnosis Manual for diagnosis of PCM or NGS.

F2 DRIVE CYCLE TEST

- While monitoring the appropriate sensor PID, drive the vehicle so that the transmission upshifts and downshifts through all gears.

Does the OSS Speed PID increase and decrease with engine and vehicle speed or is the sensor signal erratic (drop to zero or near zero and return to normal operation)?

Yes	No
If the OSS Speed PID increase and decrease with engine and vehicle speed, CLEAR all DTCs. Road test to verify if concern is still present. If concern is still present, REFER to Diagnosis by Symptom Index for diagnosis.	If the OSS Speed PID does not increase and decrease with engine and vehicle speed, INSPECT for open or short in vehicle harness, sensor, a PCM concern, or internal hardware concern.
If the sensor signal is erratic, INSPECT for intermittent	If the sensor signal is steady, GO to F3 .

concern in the internal/external harness, sensor, or connector.

F3 CHECK RESISTANCE OF OSS SENSOR

- Disconnect the OSS connector from the OSS sensor.
- Connect ohmmeter negative lead to one pin of the sensor and the positive lead to the other pin on the sensor.
- Record the resistance. Resistance should be as follows:

Sensor	Resistance (ohms)
OSS	450-750

Is the resistance within specification for the appropriate sensor?

Yes	No
REFER to Diagnosis by Symptom Index for concern diagnosis.	REPLACE sensor.

Pinpoint Test G

Test does not apply.

PINPOINT TEST H: SOLENOID MECHANICAL FAILURE

H1 ELECTRONIC DIAGNOSTIC

NOTE: Service all other DTCs before servicing the following DTCs: P1714, P175, P1740.

- If any of the following DTCs P1714, P1715, P1740 are present continue with test.

Are other DTCs present for TFT or shift solenoids?

Yes	No
SERVICE the DTCs for TFT or shift solenoids first. CLEAR DTCs and PERFORM transmission drive cycle test. RERUN Quick Test.	REPLACE the appropriate solenoid and body. REFER to the On-Board Diagnostic Trouble Code Description chart for code description. GO to H2 .

H2 TRANSMISSION DRIVE CYCLE TEST

- Perform transmission drive cycle test.
- Perform on-board diagnostic quick test.

Does the vehicle up shift or down shift OK?

Yes	No
GO to H3 .	REFER to Diagnosis by Symptom to diagnose shift concerns.

H3 DTC CODES

- Check for DTCs retrieved during quick test.

Are DTCs P1714, P1715, P1740 still present?

Yes	No
REPLACE powertrain control module . ROAD TEST and RERUN Quick test.	Testing completed. If concern still exists, refer to the Diagnosis by Symptom Index for concerns diagnosis.

Special Testing Procedures

Engine Idle Speed Check

Refer to the Powertrain Control/Emissions Diagnosis Manual for the appropriate procedure.

Line Pressure Test

This test verifies that the line pressure is within specification.

1. Connect pressure gauge to line pressure tap.

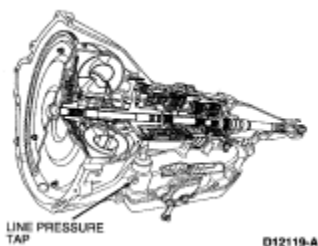

2. Start engine and check line pressures. Refer to Reference: Pressure Chart #401 to determine if line pressure is within specification.

CAUTION: Perform line pressure test prior to performing stall speed test. If line pressure is low at stall, do not perform stall speed test or further transmission damage will occur. **DO NOT MAINTAIN WOT** in any transmission range **FOR MORE THAN FIVE SECONDS.**

CAUTION: Transmission tester **MUST BE REMOVED** from the transmission and the vehicle harness reinstalled to verify these pressures. Improper pressure readings may lead to improper parts replacement or internal damage.

3. If line pressure is not within specification, check EPC pressure.
4. Connect pressure gauge to EPC pressure tap.

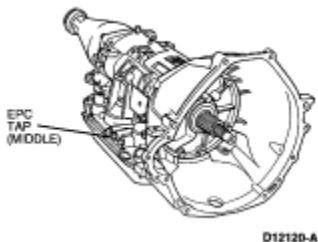

5. Restart engine and check EPC pressure. Refer to Reference: Pressure Chart #401.

REFERENCE: PRESSURE CHART #401

Application	Range	Idle	WOT Stall

		TV EPC	Line Pressure	TV EPC	Line Pressure
4.6L (2V) HO Mustang	P, N, OD, 2, 1,	20-30 PSI	63-102 PSI	83-93 PSI	160-210 PSI
	R	5-15 PSI	64-99 PSI	83-93 PSI	207-267 PSI
3.8L Mustang	P, N, OD, 2, 1	10-20 PSI	47-86 PSI	83-93 PSI	160-210 PSI
	R	0-9 PSI	67-109 PSI	83-93 PSI	207-267 PSI

6. If EPC pressure is not within specification, perform Pinpoint Test E to diagnose EPC operation. If EPC operation is OK, refer to Line Pressure Test Chart for line pressure concern causes.

Line Pressure Test Chart

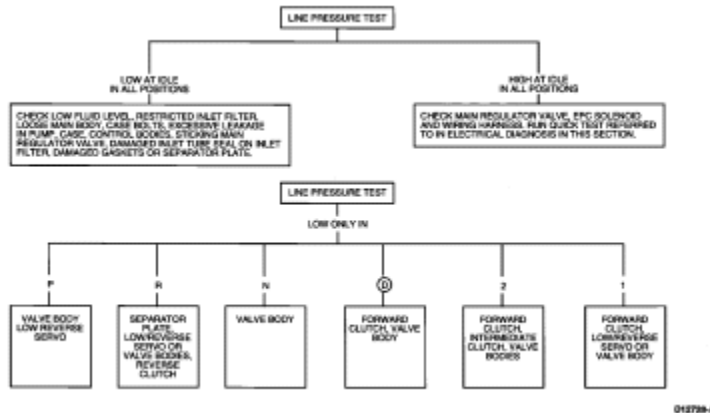

Stall Speed Test

The stall speed test checks torque converter clutch operation and installation, the holding ability of the forward clutch, reverse clutch (the low-reverse bands), the planetary one-way clutch, and engine performance.

Conduct this test with the engine coolant and transmission fluid at proper levels and at normal operating temperature.

Apply the service and parking brake control (2780) firmly for each stall speed test.

1. Find the specified stall rpm for the vehicle by referring to Specifications. Use a grease pencil to mark the rpm on the dial of a tachometer.

STALL SPEED

Engine	rpm
3.8L	2197-2567
4.6L	2362-2807

2. Connect tachometer to engine.
3. **NOTE: If the rpm recorded by the tachometer exceeds the maximum limits given in Specifications, release the accelerator pedal immediately because clutch or band slippage is indicated.**

In each of the following ranges: (D), 2, 1, R, press the accelerator pedal to the floor and hold it just long enough to let the engine get to wide open-throttle. While making this test, do not hold the throttle open for more than five seconds at a time.

4. Note the results in each range.
5. After each range, move the selector lever to NEUTRAL and run the engine at 1000 rpm for about 15 seconds to cool the torque converter (7902) before making the next test.

6. Refer to the following chart for corrective actions.

STALL SPEED OUT OF SPECIFICATION DIAGNOSIS

Selector Position	Stall Speeds High	Stall Speeds Low
(D)	Planetary One-Way Clutch	
(D), 2 and 1	Forward Clutch or Intermediate Clutch	
(D), 2, 1 and R	Perform Line Pressure Test	Torque Converter Stator One-Way Clutch or Engine Performance
R	Reverse Clutch or Low Reverse Band or Servo	

Air Pressure Tests

SPECIAL SERVICE TOOL(S) REQUIRED

Description	Tool Number
Transmission Test Plate	307-246 (T92P-7006-A)

A NO DRIVE condition can exist, even with correct transmission fluid pressure, because of inoperative clutches or bands. An ERRATIC SHIFT can be located through a series of checks by substituting air pressure for fluid pressure to determine the location of the malfunction.

Follow the procedure to determine the location of the inoperative clutch or band by introducing air pressure into the various test plate passages.

NOTE: Use only dried, regulated (276 kPa [40 psi] maximum) air pressure with Rubber-Tipped Air Nozzle 100-D009 (D93L-7000-A) or equivalent. Apply air to the appropriate passage(s). A dull thud should be heard when the clutch or band applies. There should be no hissing sound when the clutch or band is fully applied.

Cover the vent hole in the test plate with a clean, lint-free shop towel to prevent spray when the air is applied. Plugging the vent hole during testing will result in inaccurate results.

Test Procedures

1. Drain transmission fluid and remove the transmission fluid pan.
2. Remove the main control and gasket.
3. Install AOD-E Transmission Test Plate 307-246 (T92P-7006-A) and Replacement Gasket 307-247 (T92P-7006-A1). Tighten bolts to 9-11 Nm (87-90 lb-in).
4. **NOTE: Do not apply air to the test plate vent hole. Apply air to the appropriate clutch port. Refer to Transmission Test Plate Illustration.**

A dull thud may be heard or movement felt when the clutch is applied or released. If clutch seals or check balls are leaking a hissing sound may be heard.

Reverse Clutch

A dull thud can be heard when the reverse clutch piston (7D402) applies. In addition, movement of the reverse clutch drum (7D044) may also be detected.

Forward Clutch Cylinder

A dull thud can be heard or movement of the clutch piston (7A262) can be felt on the case (7005) as the clutch piston is applied.

Intermediate Clutch Cylinder

A dull thud can be heard or felt when the intermediate clutch piston (7E005) applies.

Direct Clutch Cylinder

A dull thud should be heard or felt on the driveshaft if the clutch is operating.

Overdrive Servo

Operation of the band is indicated by the tightening of the band around the reverse clutch drum . The O/D servo will return to the release position as a result of force from the overdrive servo piston return spring (7F201) . Also, when the servo returns to the release position, a thud can be felt on the O/D servo retaining ring. The band will then relax.

Low-Reverse Servo

A dull thud can be heard when the low-reverse band tightens around the planetary assembly drum surface. Also, movement of the ring gear (7A153) can be detected.

2-3 Accumulator

The accumulator piston (7F251) should unseat. This can be detected by inserting a metal rod into the 2-3 piston hole. When the accumulator piston unseats, the rod will move. Also, a thud can be heard when the accumulator piston applies.

Transmission Test Plate

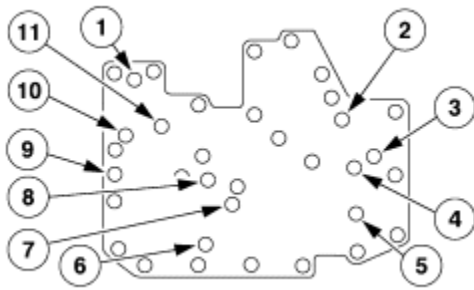

AD2577-A

Item	Part Number	Description
1	—	Converter Bypass
2	—	Direct Clutch
3	—	Forward Clutch
4	—	2-3 Accumulator Top
5	—	2-3 Accumulator Bottom
6	—	Overdrive Servo Apply
7	—	Reverse Servo
8	—	Overdrive Servo Release
9	—	Intermediate Clutch
10	—	Reverse Clutch
11	—	1-2 Accumulator Apply

Air Pressure Test Results

If the servos do not operate, disassemble, clean and inspect them to locate the source of the concern.

If air pressure applied to the clutch passages fails to operate a clutch, or operates clutches simultaneously, inspect the fluid passages in the case.

If air pressure applied to the accumulator fails to operate an accumulator, remove and inspect case passages and piston.

Direct Clutch Pressure Test

The direct clutch pressure test will diagnose a low-pressure condition or leakage in the direct clutch circuit. A difference of 103 kPa (15 psi) or more between direct clutch pressure and line pressure (read at the forward clutch pressure tap) will prevent a normal 3-4 shift.

-  **CAUTION: Pressure gauges affect the shift quality of the transmission. Care should be taken not to accelerate or decelerate rapidly. Possible transmission failure could result.**

Attach 0-2000 kPa (0-300 psi) pressure gauges to the forward clutch pressure tap and to the direct clutch pressure tap. Gauges must be accurate enough to distinguish a 103 kPa (15 psi) difference. (If this test is done in conjunction with a line pressure test, pressure gauges will be attached to all pressure taps.) Have sufficient flexible hose to read the gauges in the vehicle.

- Drive the vehicle. When pressure is applied to the direct clutch, note the difference between the pressure read at forward clutch pressure tap and the direct clutch pressure.
- If the difference in pressures is less than 103 kPa (15 psi), the direct clutch circuit is OK.
- If the difference is greater than 103 kPa (15 psi), there could be a leak in the direct clutch pressure circuit. If the difference does not exceed 103 kPa (15 psi), the gauges on the line pressure and direct clutch pressure can be switched to confirm that gauge calibration difference is not the cause.

Shift Linkage Check

This is a **CRITICAL** adjustment. Be sure the (D) detent in the transmission corresponds exactly with the stop in the steering column tube (3514) . Hydraulic leakage at the manual control valve can cause delay in engagements and/or slipping while operating if the linkage is not correctly adjusted.

NOTE: Check for a misadjustment in shift linkage. Do this by matching the detents in the transmission gearshift lever with those in the transmission. If they match, the misadjustment is in the indicator. Do not adjust the shift linkage.

Leakage Inspection

Check the vehicle speed sensor (VSS) (9E731) , output shaft speed sensor (OSS) and the connector at transmission. Replace the rubber seal, if necessary.

NOTE: Fluid from other external sources can collect between the case and pan rail to give the appearance of a pan-to-case gasket leak. If fluid is present check the following positions as described.

Check for leakage at pan-to-case gasket.

Leakage at the pan to case gasket often can be stopped by tightening the retaining bolts to 13-15 Nm (117-132 lb-in). Do not over-tighten transmission pan bolts. If necessary, replace the pan to case gasket.

If leakage is found at the wiring connector bulkhead assembly, replace the O-ring. Refer to Disassembly/Assembly for procedures.

Check the fluid filler tube connection at the transmission case or transmission pan. If leakage is found here, install a new O-ring and press the fluid filler tube to the case. The fluid filler tube bracket should align properly and be attached to the transmission or engine.

Check the fluid tubes and fittings between the transmission and the transmission radiator in the tank cooler for looseness, wear or damage. When fluid is found to be leaking at the cooler tube nuts, tighten the cooler tube nuts to 20-26 Nm (15-19 lb-ft). If the leak continues replace the cooler tube(s) or cooler tube nuts and tighten to 20-26 Nm (15-19 lb-ft).



CAUTION: Do not try to stop the fluid leak by increasing the torque beyond specification. This may cause damage to the case threads.

The same procedure should be followed for leaks between the case and cooler tube-to-case connector nut. Tighten this nut to 24-31 Nm (18-22 lb-ft). If leak continues, replace the cooler tube nut to case connector and tighten to 24-31 Nm (18-22 lb-ft).

Check the engine coolant in the radiator (8005) . If transmission fluid is present in the coolant, the transmission cooler in the radiator is probably leaking.

The transmission cooler can be further checked for leaks by disconnecting the cooler tube and cooler inlet tube from the cooler fittings and applying 345-517 kPa (50-75 psi) air pressure to the fittings. Remove the radiator cap (8100) to relieve the pressure buildup at the exterior of the cooler tank. If the transmission cooler is leaking and/or will not hold pressure, the transmission cooler must be replaced. Refer to [Section 07-02](#) for transmission cooler replacement procedure.

If leakage is found at the manual control lever (7A256) , replace the manual control lever seal.

The transmission has five pipe plugs: four on the RH side of the case and one on the LH side. Inspect the plugs for leakage. Make sure they are tightened to 8-16 Nm (71-141 lb-in). If tightening of the pipe plugs does not stop the leak, replace the plug.

When a converter drain plug leaks, remove the drain plug with a six-point wrench. Coat the threads with Pipe Sealant with Teflon® D8AZ-19554-A or equivalent meeting Ford specification WSK-M2G350-A2 and install plug. Tighten the drain plug to 28-30 Nm(21-22 lb-ft). Fluid leakage from the converter housing may also be caused by engine oil leaking past the rear main bearing seal, or from oil galley plugs. Verify the exact cause of the leak before starting service procedures.

External Sealing

The 4R70W transmission has the following parts to prevent external fluid leakages:

Seals and Gaskets

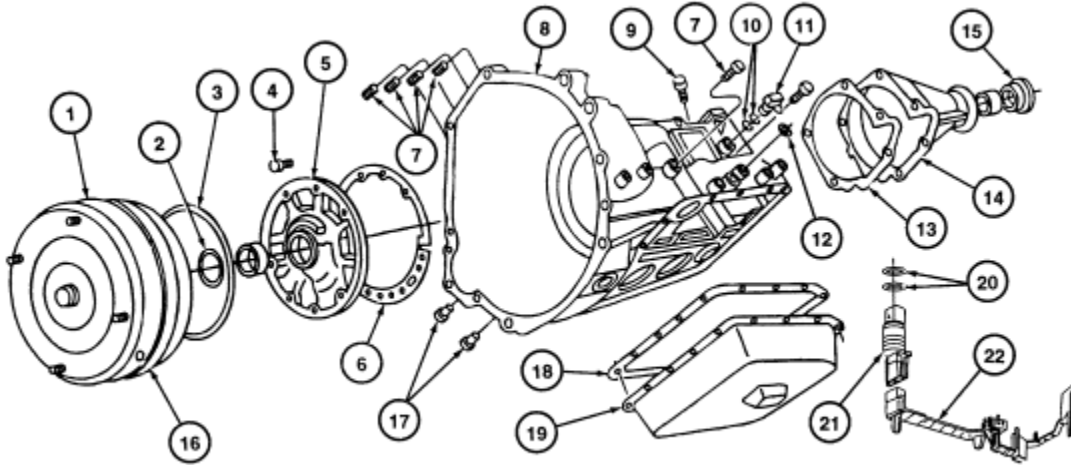

AD1542-A

Item	Part Number	Description
1	7902	Torque Converter
2	7A248	Front Oil Pump Seal
3	7A248	Front Oil Pump Seal
4	N605789-S100	Bolt
5	7A106	Front Pump Body Assembly
6	7A136	Oil Pump Gasket
7	390318-S100	Pipe Plug — 1/8 — 27 Dryseal Tapered
8	7005	Case
9	7034	Vent
10	7Z101	Turbine Speed Sensor Seal
11	7H103	Output Shaft Speed (OSS) Sensor
12	7B498	Manual Control Lever Seal Assembly
13	7086	Extension Housing Gasket
14	7A039	Extension Housing
15	7052	Oil Seal
16	87650-S2	Plug — Converter Drain — 1/8 — 27 Dryseal
17	7D273	Oil Tube Connector
18	7A191	Oil Pan to Case Gasket
19	7A194	Transmission Fluid Pan
20	7Z276	O-Ring Seal
21	7G276	Bulkhead Assembly Wiring Connector
22	7G276	Bulkhead Assembly Wiring Connector (Molded)

Fluid Leakage in Torque Converter Area

In diagnosing and correcting fluid leaks in the front pump support and gear and torque converter area, use the following procedures to locate the exact cause of the leakage. Leakage at the front of transmission, as evidenced by fluid around the torque converter housing, may have several sources. By careful observation, it is possible, in many instances, to pinpoint the source of leak before removing the transmission from the vehicle. The paths which the fluid takes to reach the bottom of the torque converter housing are shown in the following illustration.

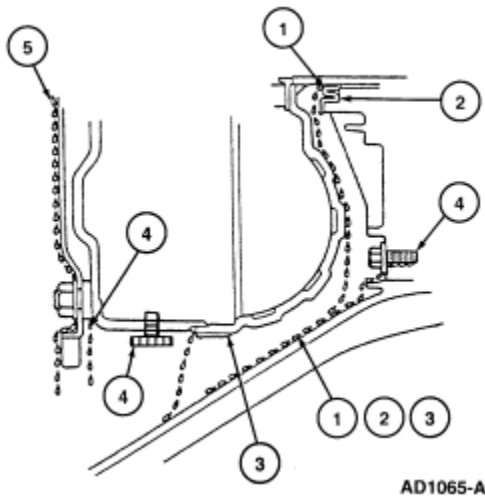

1. Fluid leaking by the pump lip seal will tend to move along the impeller hub and onto the back of the impeller housing. Except in the case of a total seal failure, fluid leakage by the lip of the pump seal will wet the back of the torque converter and be deposited on the torque converter housing only, near the pump body.
2. Fluid leakage by the outside diameter seal of the pump body will be deposited only on the pump body and torque converter housing. Fluid will not be deposited on the back of the torque converter.
3. Fluid that leaks by the pump gasket and front pump-to-case bolt will be deposited on the inside of the torque converter housing only. Fluid will not be deposited on the back of the torque converter .
4. Fluid leakage from the converter drain plug (model dependent), or stud weld will appear at the outside diameter of the torque converter , on the back face of the flexplate, and in the converter housing only near the flexplate. Fluid leaks from the torque converter will leave a ring of fluid around the inside of the torque converter housing.
5. **NOTE: A clean lint-free cloth may aid in determining the color (transmission fluid is red) and source of the leaking fluid.**

Engine oil leaks are sometimes improperly diagnosed as transmission pump gasket leaks. The following areas of possible leakage should also be checked to determine if engine oil leakage is causing the concern.

- a. Leakage at the valve cover gasket (6584) may allow oil to flow over the torque converter housing or seep down between the torque converter housing and cylinder block (6010) causing oil to be present in or at the bottom of the torque converter housing.
- b. Oil galley plug leaks will allow oil to flow down the rear face of the cylinder block to the bottom of the torque converter housing.
- c. Leakage at the crankshaft rear oil seal (6701) will work back to the flexplate, and then into the torque converter housing.
- d. Leakage at oil pressure sensor (9278).

Leak Check Test

Fluid leakage from other areas, such as the power steering system forward of the transmission, could cause fluid to be present around the torque converter housing due to blowback or road draft. The following procedures should be used to determine the cause of the leakage before service.

1. Remove the fluid level indicator and note the color of the fluid. Original factory fill fluid is dyed red to aid in determining if leakage is from the engine or transmission. However, a power steering leak may be mistaken for a transmission leak since both fluids are dyed red. Check the power steering system for leaks that could be misidentified as a transmission leak. Refer to [Section 11-00](#).

2. Remove the torque converter housing cover. Clean off any fluid from the top and bottom of the torque converter housing, front of the case and rear face of the engine and oil pan (6675) . Clean the torque converter area by washing with a suitable non-flammable solvent and blow dry with compressed air.
3. Wash out the torque converter housing, the front of the flexplate and the converter drain plugs. The torque converter housing may be washed out using cleaning solvent and a squirt-type oil can. Blow all washed areas dry with compressed air.
4. Start and run the engine until the transmission reaches its normal operating temperature. Observe the back of the cylinder block and top of the torque converter housing for evidence of fluid leakage. Raise the vehicle on a hoist, refer to [Section 00-02](#), and run the engine at fast idle, then at engine idle, occasionally shifting to the OVERDRIVE and REVERSE ranges to increase pressure within the transmission. Observe the front of the flexplate, back of the cylinder block (in as far as possible), and inside the torque converter housing and front of the case . Run the engine until fluid leakage is evident and the probable source of leakage can be determined.

Leak Check Test with Black Light

Oil soluble aniline or fluorescent dyes premixed at the rate of 2.5ml (1/2-teaspoon) of dye powder to 0.23 liter (1/2-pint) of transmission fluid have proved helpful in locating the source of fluid leakage. Such dyes may be used to determine whether an engine oil or transmission fluid leak is present, or if the fluid in the oil cooler leaks into the engine coolant system. A black light must be used with the fluorescent dye solution.

Transmission Fluid Cooler



CAUTION: Whenever a transmission has been disassembled to replace worn or damaged parts the cooler bypass valve (CBV), all transmission fluid coolers (in tank and auxiliary) and transmission fluid cooler lines must be cleaned and backflushed. Use the torque converter/oil cooler cleaner.

NOTE: Cleaning and backflushing the transmission fluid cooling system along with following all the normal cleaning and inspection procedures as outlined in this section during disassembly and reassembly will keep contamination from reentering the transmission and causing a repeat repair.

When internal wear or damage has occurred in the transmission, metal particles, clutch plate material, or band material may have been carried into the torque converter and transmission fluid cooler (7A095) . These contaminants are a major cause of recurring transmission troubles and must be removed from the system before the transmission is put back into use.

Transmission Fluid Cooler Flow Test

NOTE: The transmission linkage/cable adjustment, fluid level and line pressure must be within specification before performing this test; refer to [Section 07-05](#) for adjustments.

1. Remove fluid level indicator from fluid filter tube.
2. Place funnel in fluid filler tube.
3. Raise the vehicle on a hoist; refer to [Section 00-02](#) and place suitable safety stands under the vehicle.
4. Remove the cooler return line (bottom fitting) from the fitting on the transmission case.
5. Connect one end of a hose to the cooler return line and route other end of the hose up to a point where it can be inserted into the funnel at the fluid filler tube.
6. Remove the safety stands and lower the vehicle. Insert end of hose into the funnel.
7. Start the engine and run it at idle with the transmission in Neutral position.
8. Once a steady flow of fluid (without air bubbles) is observed, remove the hose from the funnel and place the hose in a measuring container for 15 seconds. After 15 seconds place the hose back into the funnel and turn the engine off. Measure the amount of fluid in a container. If adequate flow was observed, approximately 1 liter (1 quart) will be in the measuring container; the test is now complete.
9. If the flow is not liberal, stop the engine. Disconnect the hose from the cooler return line and connect it to the converter outline fitting (top fitting) on the transmission case.
10. Repeat Steps 7 and 8. If flow is now approximately 1 liter (1 quart) in 15 seconds, refer to transmission removal for cleaning and backflushing. If the flow is still not approximately 1 liter (1 quart) in 15 seconds, service the pump and/or converter.

Transmission Fluid Cooler or Tube Replacement

Refer to [Section 07-02](#).

