

MasterSheet

019 0011
Revision 07/09/07



Complete Car Audio
Installation Instructions
CRUTCHFIELD™

IMPORTANT

Before starting, compare items on your invoice with items received. Carefully check through packaging material. If any item is missing, please call **Crutchfield Technical Service at 1-800-955-9094**.

Although reasonable attempts are made to verify the accuracy of the information contained in this MasterSheet, it is presented without warranties or guarantees of any type due to the constantly changing nature of this type of information and running changes in vehicle production. Any person or entity using this information does so at his or its own risk. If you find our instructions are different from your vehicle, or if you have questions, do not continue with your installation. Contact our toll-free technical support for assistance.

2005- Ford Mustang



* 0 0 0 0 1 9 0 0 1 1 *

Inside...

Page

2-3	Factory Radio Removal	✓		✓				✓			
4	Receiver Installation	✓		✓							
5-8	Door Speakers	✓	✓					✓	✓	✓	
9	Rear Speakers (Coupe '05-06)			✓				✓	✓		
10-11	Rear Speakers (Coupe '07-)						✓	✓	✓		
12	Rear Speakers (Convertible)							✓	✓		
13-14	Rear Subwoofer (Coupe)			✓	✓	✓					✓

Tools Required ▶

Phillips Screwdriver	Small Flat Blade Screwdriver	7mm	11mm	13mm	14mm	Panel Tool	T20	T30	Drill & 1/8" Bit
		Socket, Ratchet & Extension					Torx Driver		

CRUTCHFIELD®
CRUTCHFIELD.COM

Copyright 2007 Crutchfield Corporation

019 0011

Factory Radio Removal

1. Set parking brake and disconnect negative battery cable to prevent any electrical short.
2. Open **console** and remove two (2) phillips screws at the top rear edge (Figure 1).
3. Pry up and remove **gear shift trim** (Figure 2).
4. Pry up and remove **console trim** (Figure 3).

Continued on the next page.

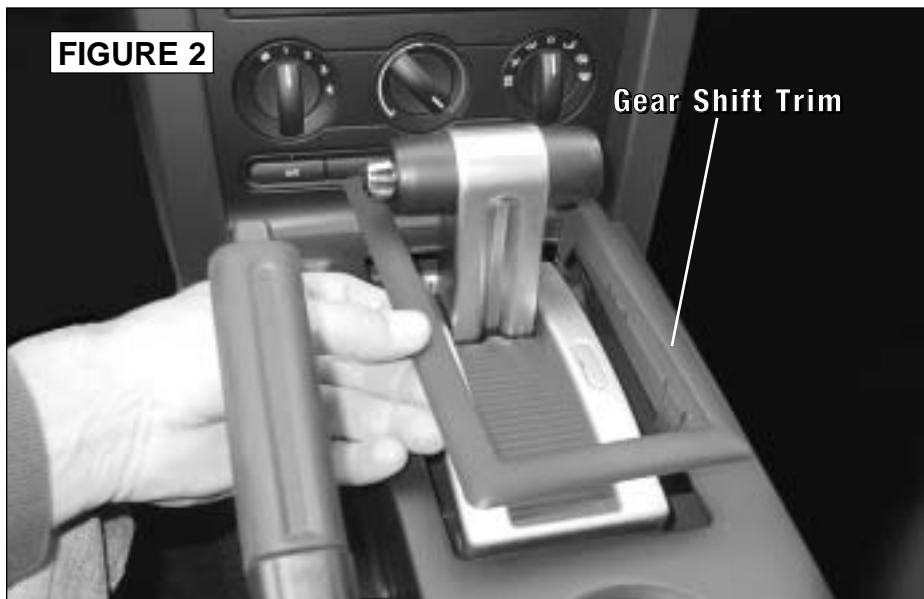
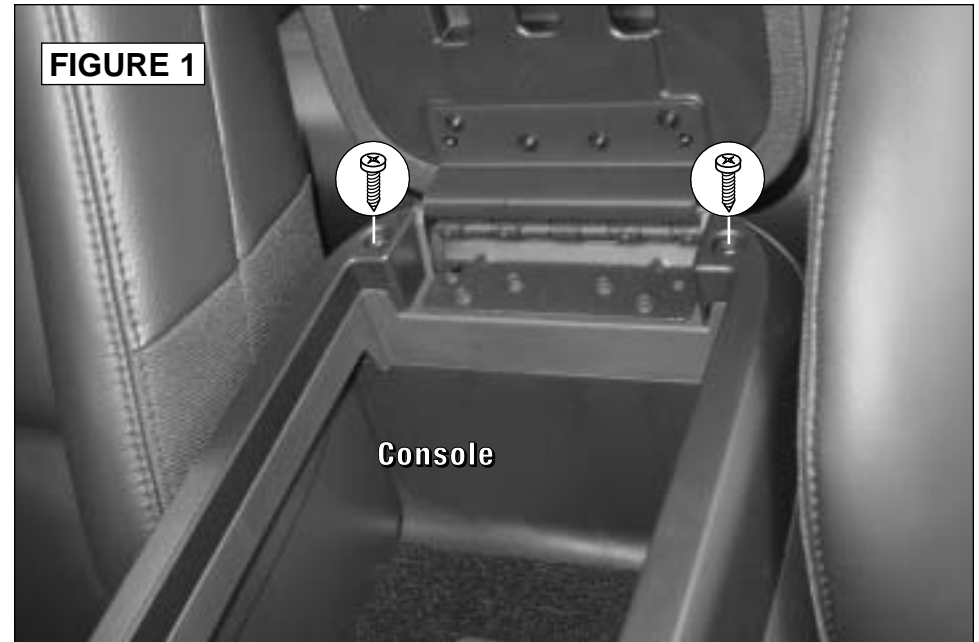

019 0011

Factory Radio Removal (continued)

5. Pry off and remove **side trimpanel** from each side of receiver and climate controls (Figures 4 & 5).
6. Remove six (6) 7mm screws (3 on each side) securing **receiver/climate control trimpanel** (Figure 6). Pull off trimpanel, disconnect wiring harnesses and remove.
7. Remove four (4) 7mm screws securing **factory radio**. Pull out radio, disconnect and remove (Figure 7).

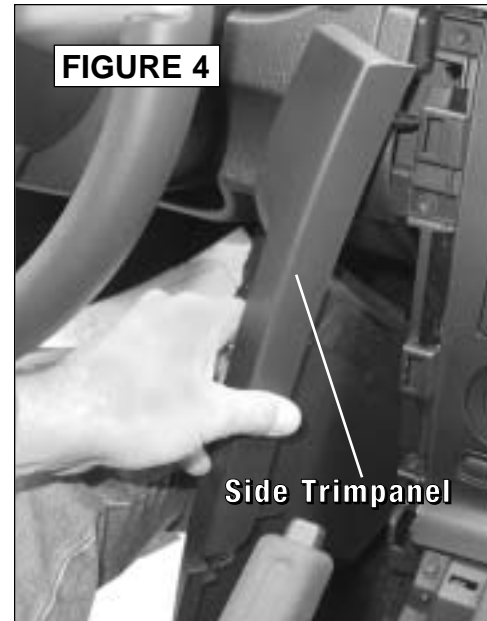

019 0011

DIN Receiver Installation

1. Secure receiver to mounting bracket following instructions supplied with the installation kit.
2. Connect receiver wiring adaptor to receiver following instructions supplied with adaptor.
3. Hold **receiver assembly** near dash. Connect receiver wiring adaptor to factory harness. Plug antenna lead into rear of receiver.
4. Slide assembly into dash and secure with screws previously removed.
5. Test operation and reassemble dash by reversing removal steps.

NOTES:

Please read first

- *Inspect factory receiver harness connector in vehicle. Ensure that the wiring adaptor received from Crutchfield plugs into the vehicle's connector. If the connector is missing or incorrect, please call our Technical Service Department at 1-800-955-9094.*

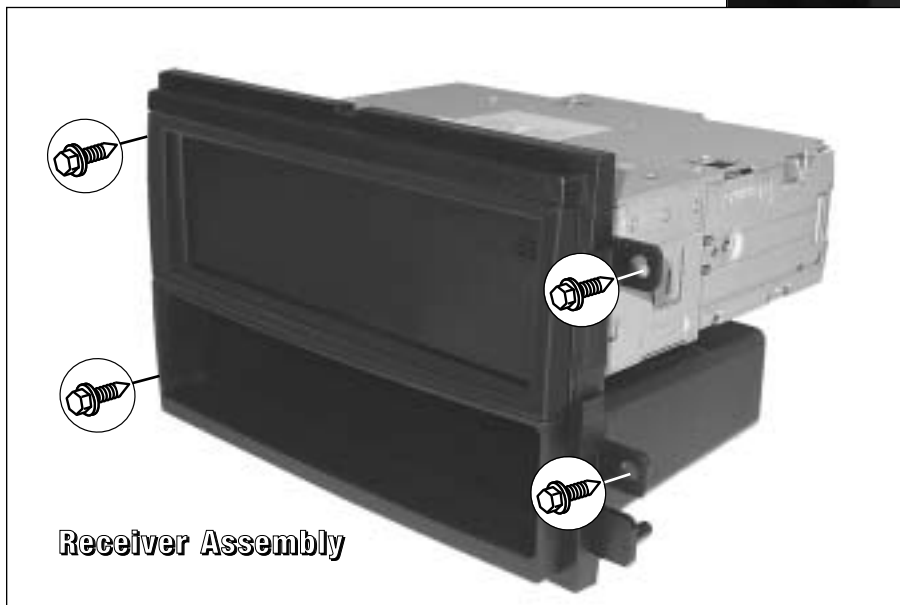
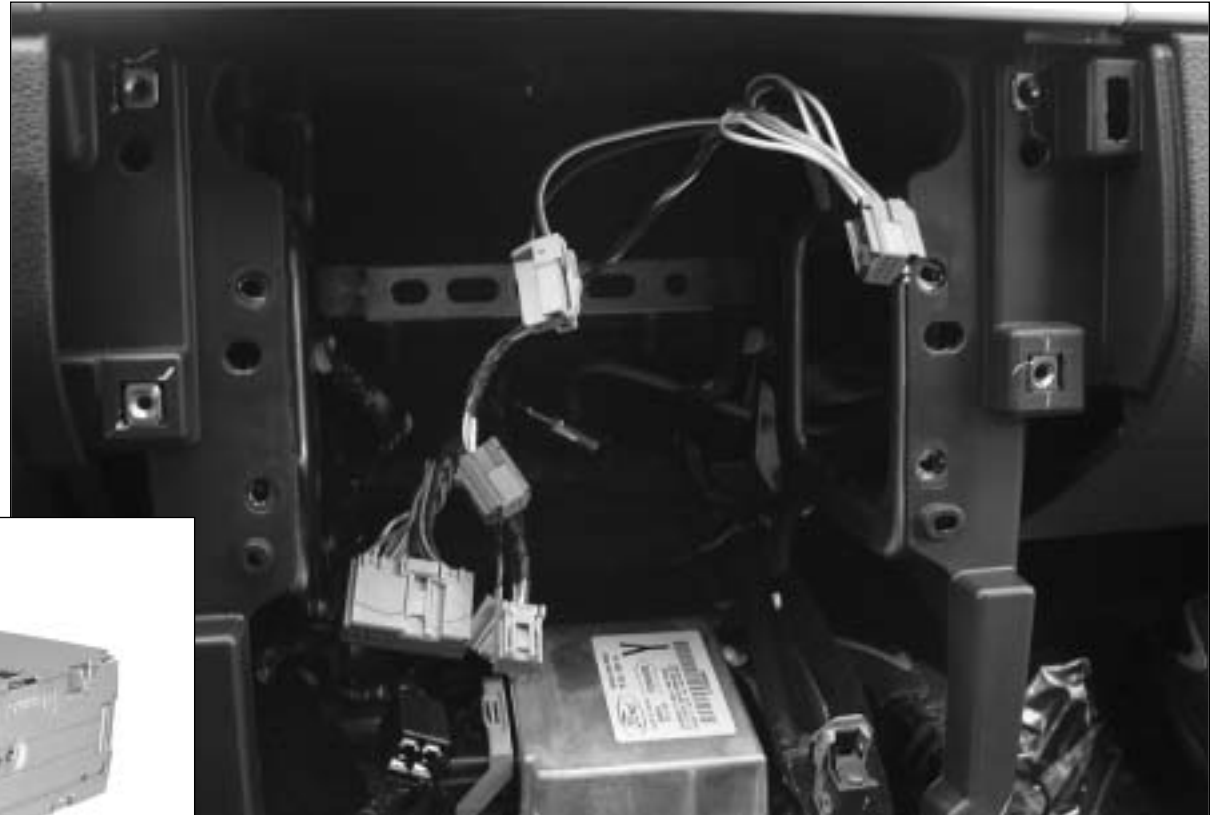

 **1-800-955-9094**
Technical Service

CRUTCHFIELD[®]
CRUTCHFIELD.COM

Copyright 2007 Crutchfield Corporation

019 0011

Door Speakers

NOTES:

Please read first

- Instructions address factory speaker locations. In most cases the replacement speaker will be a direct fit. In some cases an adaptor bracket or a fabricated bracket will be required.

1. Pry off “sail” panel and disconnect harness to remove (Figure 1).
2. Pry off screw cover in door release trim from rear edge. Remove one (1) exposed Torx T30 screw (Figures 2 & 3).
3. Pry out screw cover behind door pull handle and remove one (1) Torx T 30 screw (Figures 4 & 5).
4. Pry up power options switch panel, disconnect wiring harness and remove (Figure 6).

Continued on the next page.

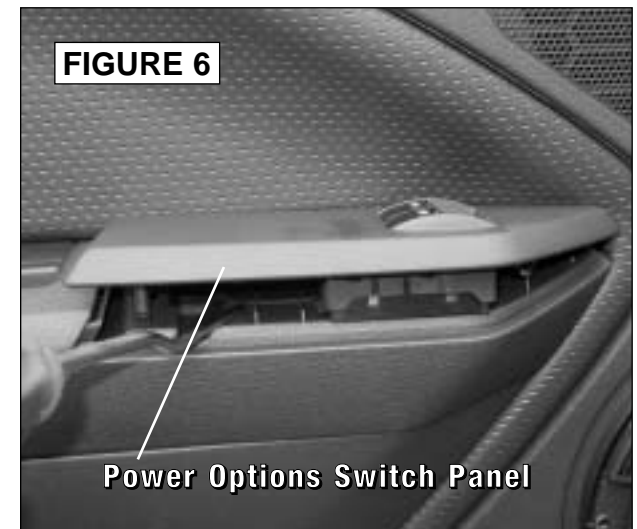
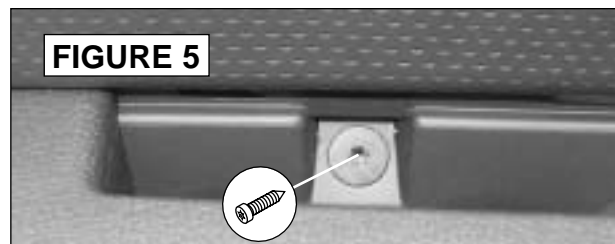
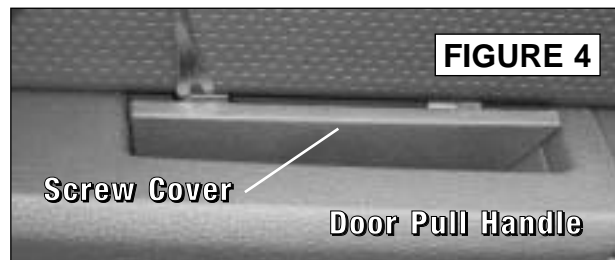
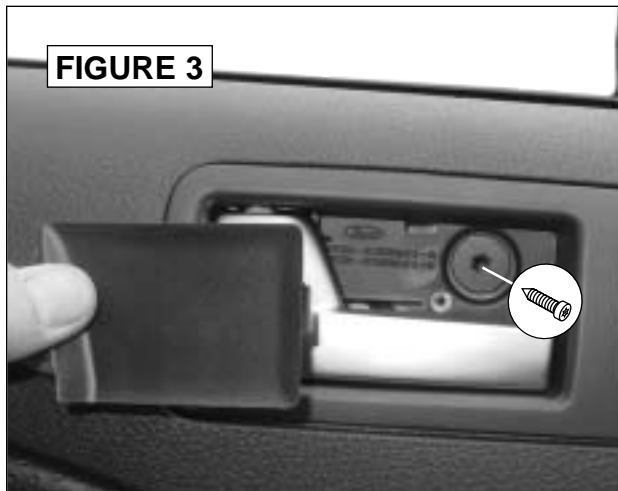

019 0011

Door Speakers (continued)

5. Remove eight (8) phillips screws from sides and bottom of door panel (Figures 7 & 8).
6. Pry off and remove **power switch housing**. Remove one (1) 7mm screw (Figure 9).
7. Lift door panel, disconnect wiring harnesses and **door release cable** to remove (Figure 10 - this page , Figure 11 - next page).

Continued on the next page.

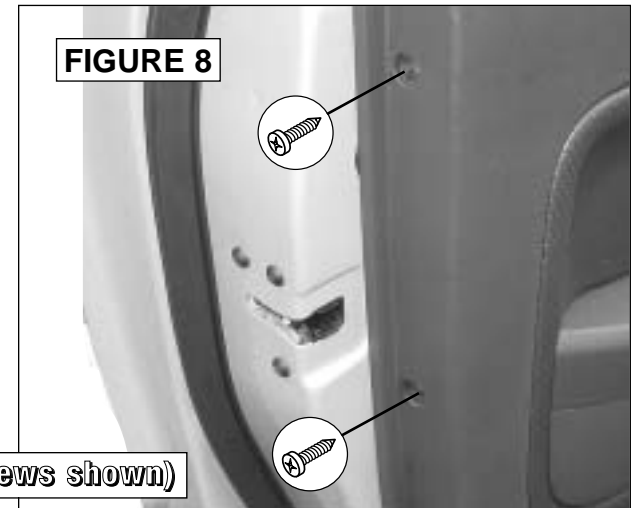
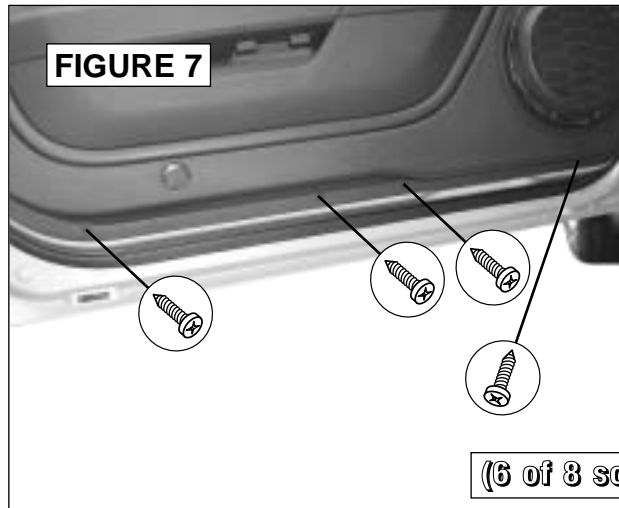

(6 of 8 screws shown)



019 0011

Door Speakers (continued)

8. Subwoofer removal and replacement (if equipped):



IMPORTANT:

This speaker is a dual voice coil subwoofer. Replacing it with a dual voice coil that is 4 ohms, each coil, could result in lower output. Screw mounting holes must be redrilled. The factory speaker ring will probably not fit the aftermarket speaker and result in a less than desirable appearance.



CAUTION:

Always be careful when drilling in a vehicle. Be aware of things such as wiring, windows, fuel lines and safety devices. Check drilling depth and location to avoid damage to vehicle appearance.

- Pry off **trim ring** on front side of door panel (Figure 12).
- Remove eight (8) exposed 7mm screws (Figure 13).

Continued on the next page.

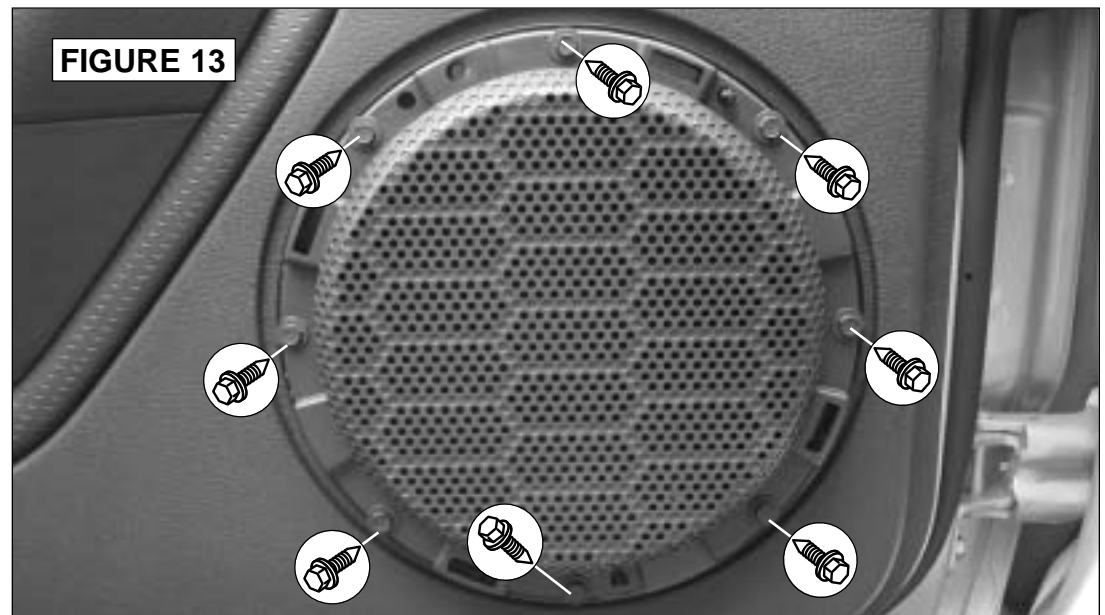
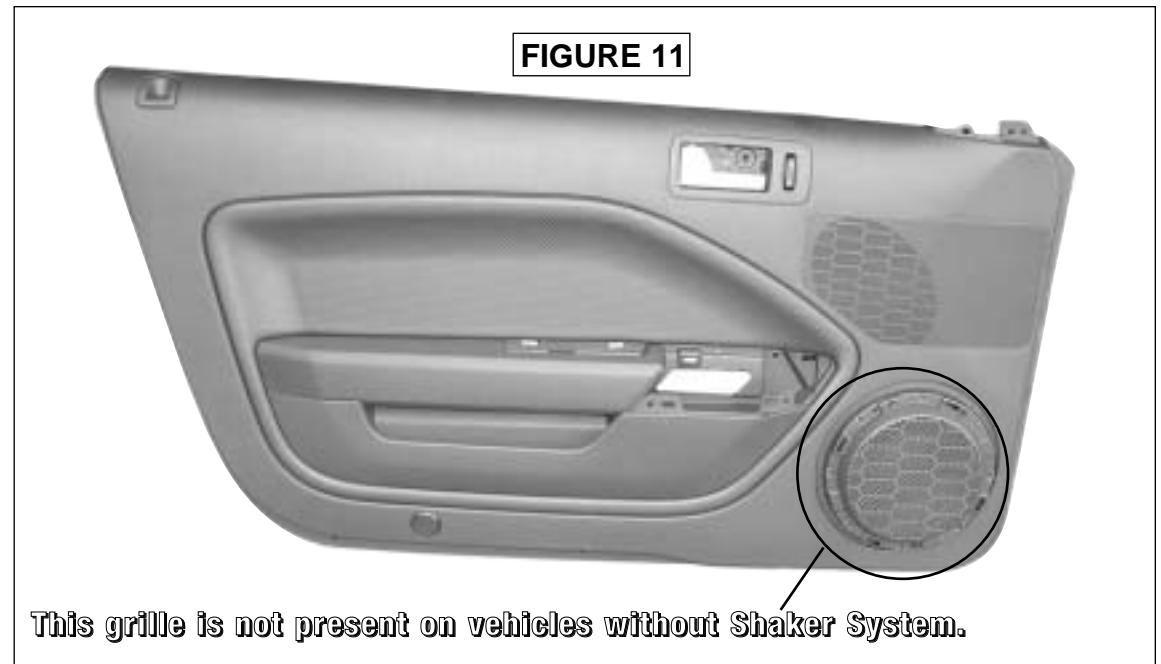

1-800-955-9094
Technical Service

CRUTCHFIELD
CRUTCHFIELD.COM

Copyright 2007 Crutchfield Corporation

019 0011

Door Speakers (continued)

- On the back of the door panel, remove one (1) 8mm screw securing speaker (Figure 14). Pull out speaker.
 - Connect speaker wiring and secure replacement speaker with screws previously removed or supplied. Test speaker operation.
- 9. Factory 6X8 speaker removal and replacement:**
- Remove four (4) Torx T20 screws securing speaker. Pull out speaker, disconnect and remove (Figure 15).
 - Connect speaker wiring adaptor of replacement speaker to vehicle speaker harness.
 - Secure new speaker with screws previously removed. Test speaker operation.
- 10.** Reinstall door panel by reversing removal steps.



SAFETY CHECK

- ✓ Check that wires do not interfere with window operation.
- ✓ Test door lock operation.

FIGURE 14

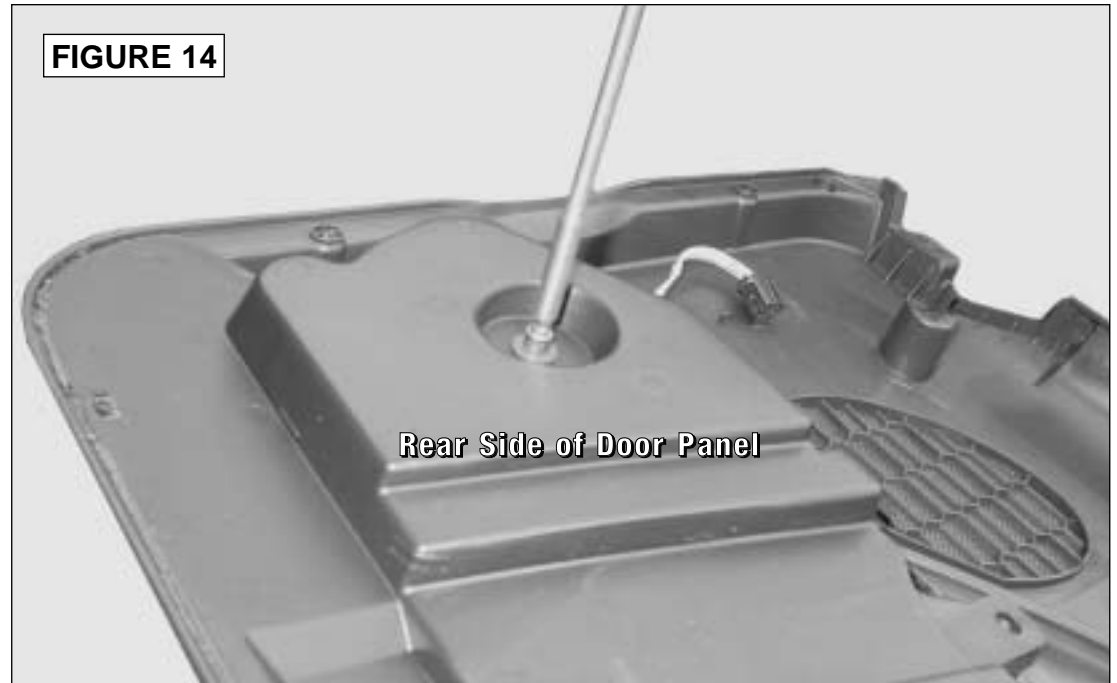

FIGURE 15



 **1-800-955-9094**
Technical Service

CRUTCHFIELD
CRUTCHFIELD.COM

Copyright 2007 Crutchfield Corporation

019 0011

Rear Speakers -- Coupe '05 & '06

1. Pry up **speaker grille** to remove (Figure 1).
2. Remove four (4) Torx T20 screws securing speaker. Pull out speaker, disconnect and remove (Figure 2).
3. Connect speaker wiring adaptor to vehicle speaker harness. Secure speaker with screws previously removed.
4. Test speaker operation and reinstall speaker grille.

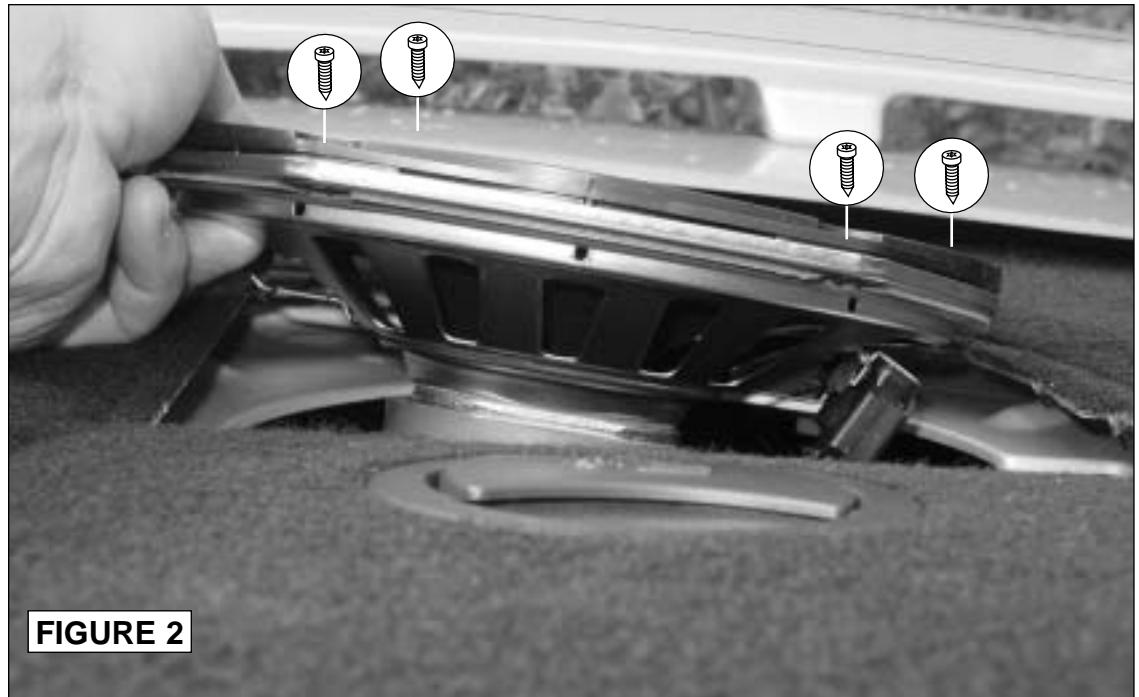
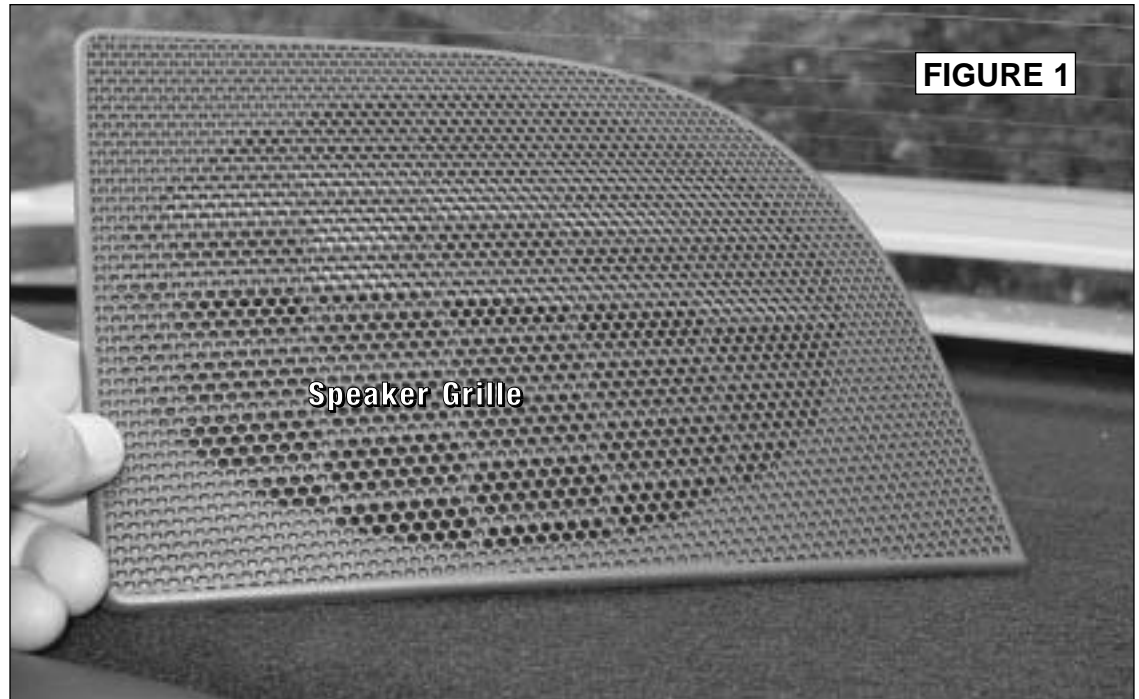

1-800-955-9094
Technical Service

CRUTCHFIELD[®]
CRUTCHFIELD.COM

Copyright 2007 Crutchfield Corporation

019 0011

Rear Speakers -- Coupe '07-

1. Fold down both rear seat backs.
2. Pry open the **clothing hook cover**. Remove one (1) exposed Torx T20 screw (Figure 1).
3. Pry off **seat belt anchor cover** and remove one (1) 14mm bolt (Figure 2).
4. Pry out two (2) clips on back of **rear seat side panel** (Figure 3).
5. Pull down **side headliner trim** and pull out **lower rear side panel** to release clips from **quarter window trim** (Figure 4).

Continued on the next page.

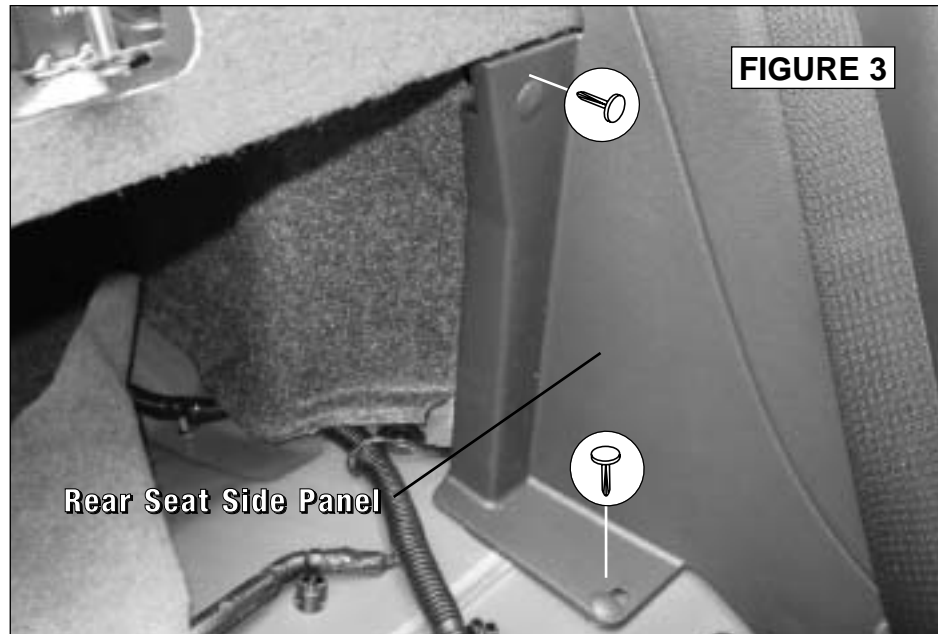

1-800-955-9094
Technical Service

CRUTCHFIELD
CRUTCHFIELD.COM

Copyright 2007 Crutchfield Corporation

019 0011

Rear Speakers -- Coupe '07- (continued)

6. Pull quarter window trim toward front of vehicle to remove (Figure 5).
7. Repeat steps 2 through 6 for the opposite side of car.
8. Pry out four (4) clips from front edge of **rear deck panel** (Figure 6).
9. Pull rear deck panel toward the front of vehicle and work over rear side panels to remove (Figure 7).
10. Remove four (4) Torx T20 screws securing speaker. Pull out speaker, disconnect and remove (Figure 8).
11. Connect speaker wiring adaptor of replacement speaker to vehicle speaker harness. Secure new speaker with screws previously removed
12. Test speaker operation and reassemble rear of vehicle by reversing disassembly steps.

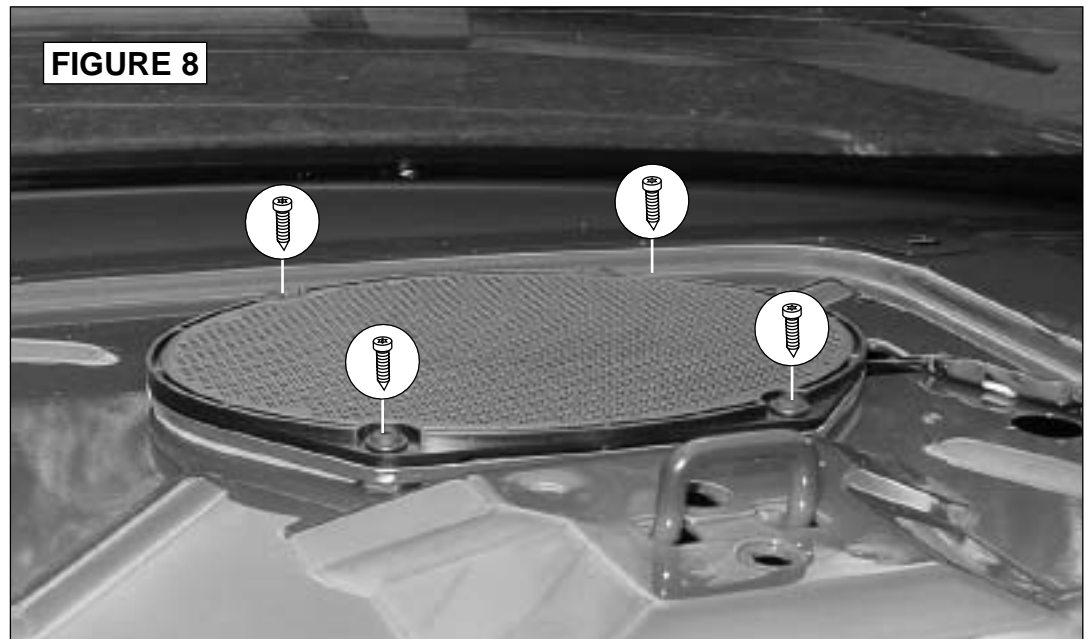

1-800-955-9094
Technical Service

CRUTCHFIELD[®]
CRUTCHFIELD.COM

Copyright 2007 Crutchfield Corporation

019 0011

Rear Speakers -- Convertible

NOTES:

Please read first

- Instructions address factory speaker locations. In most cases the replacement speaker will be a direct fit. In some cases an adaptor bracket or a fabricated bracket will be required.

1. Pry up and remove **top portion** of rear side panel (Figure 1).
2. Pry **side panel** from side wall to release clips (Figure 2).
3. Hold out enough to remove four (4) Torx T20 screws securing speaker. Pull out speaker, disconnect and remove (Figure 3).
4. Connect speaker wiring adaptor or replacement speaker to vehicle speaker harness. Secure speaker with screws previously removed.
5. Test speaker operation and reinstall side panel.

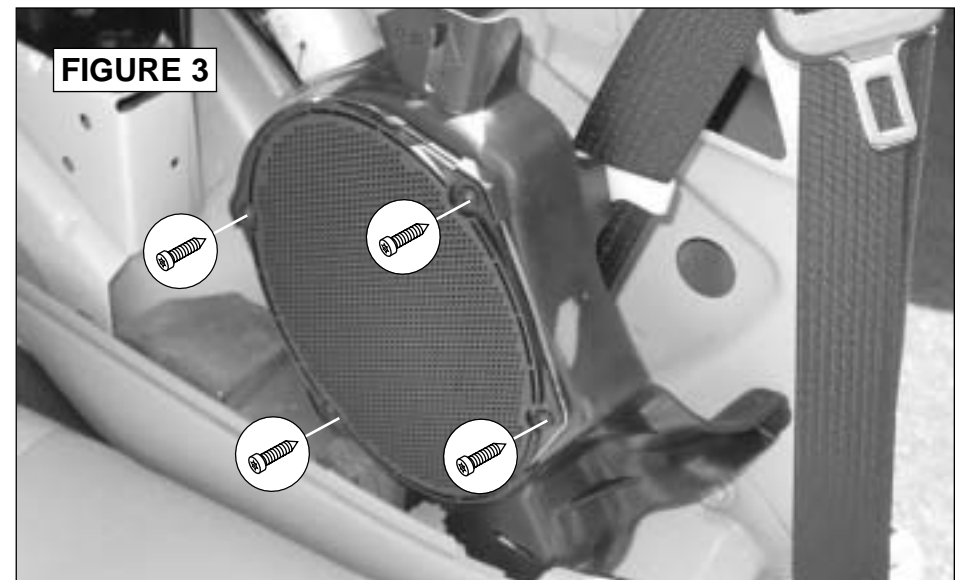
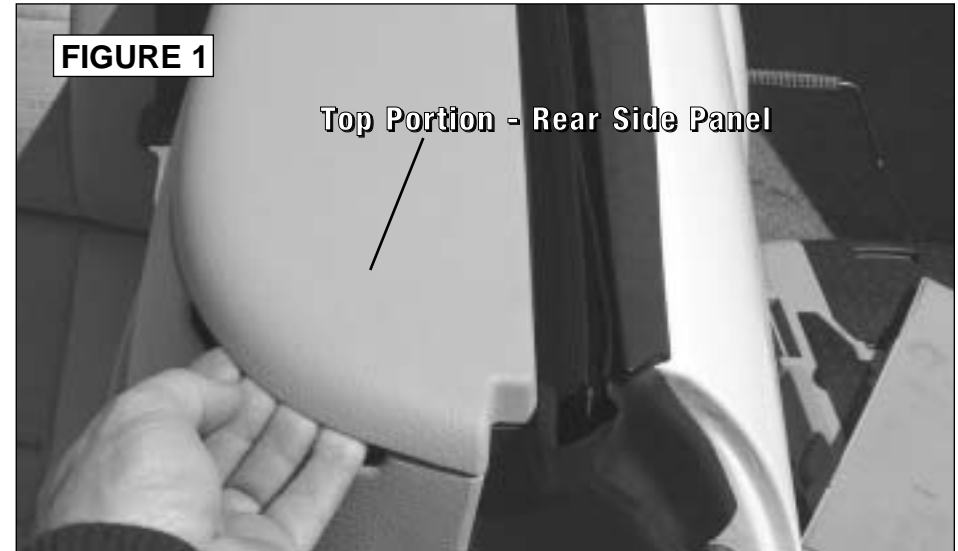

1-800-955-9094
Technical Service

CRUTCHFIELD
CRUTCHFIELD.COM

Copyright 2006 Crutchfield Corporation

019 0011

Subwoofer -- Coupe

NOTES:

Please read first

- Instructions address factory speaker locations. In most cases the replacement speaker will be a direct fit. In some cases an adaptor bracket or a fabricated bracket will be required.

1. Remove two (2) 13mm bolts and one (1) 13mm nut securing the **subwoofer enclosure** (Figure 1).
2. Pull **trunk floor liner** towards the left side wall. Remove one (1) exposed 13mm bolt (Figure 2).
3. Pull out enclosure, disconnect and remove.

Continued on the next page.

FIGURE 1



FIGURE 2

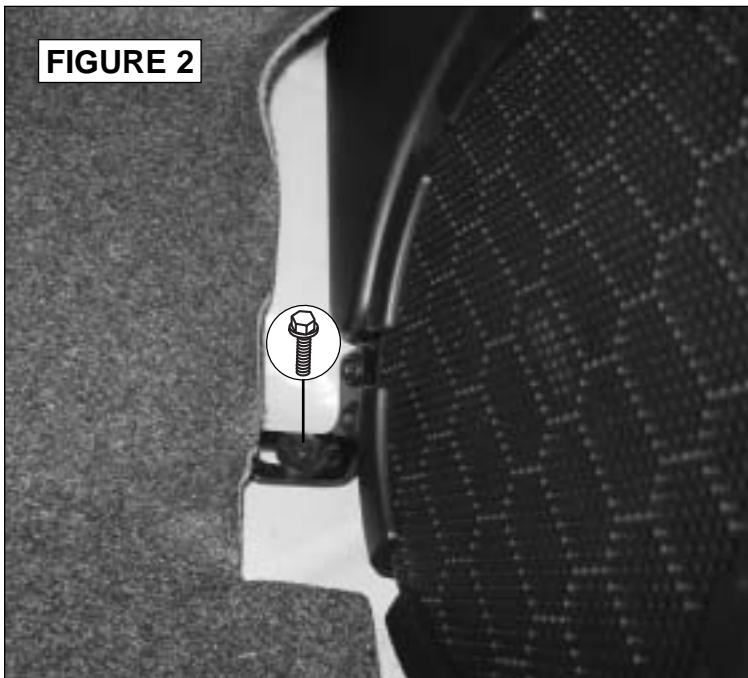

019 0011

Subwoofer -- Coupe (continued)

4. Remove one (1) 11mm nut from back of enclosure (Figure 3).
5. Remove eight (8) 7mm screws on front of subwoofer, disconnect harnesses and remove (Figure 4).
6. Place new speaker in enclosure location and mark new mounting holes. Remove speaker and drill holes with a 1/8" bit.
7. Make wiring connections and test operation.
8. Secure speaker to enclosure with hardware supplied.
9. Reinstall speaker/enclosure by reversing removal steps.



CAUTION:

Always be careful when drilling in a vehicle. Be aware of things such as wiring, windows, fuel lines and safety devices. Check drilling depth and location to avoid damage to vehicle appearance.



1-800-955-9094
Technical Service

CRUTCHFIELD
CRUTCHFIELD.COM

Copyright 2006 Crutchfield Corporation