

ACCELERATOR  
PEDAL POSITION SENSOR  
151-16

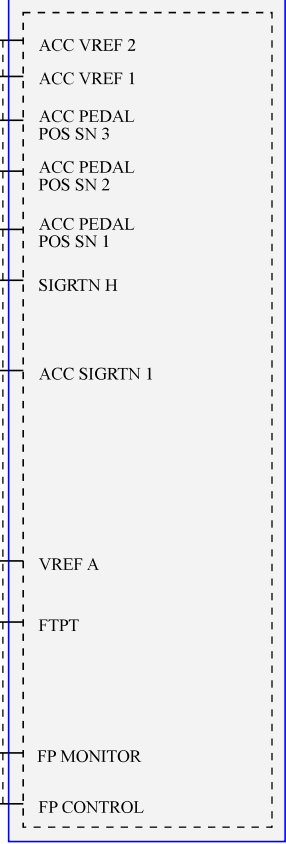

ELECTRONIC ENGINE CONTROLS

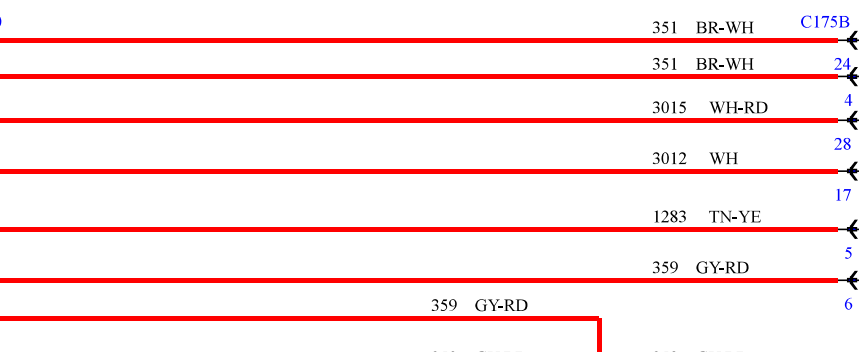
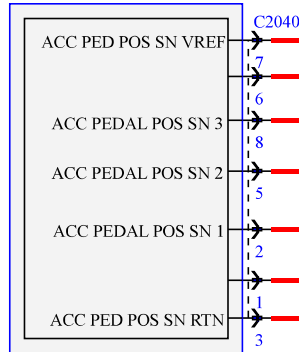
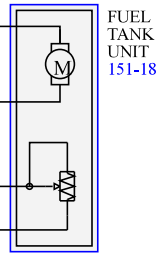
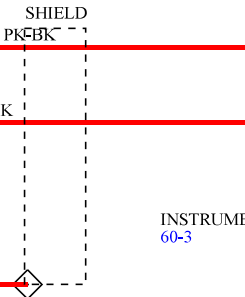
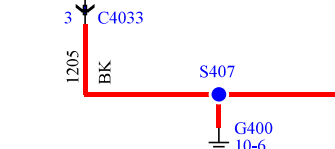
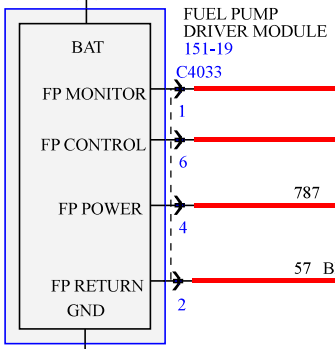
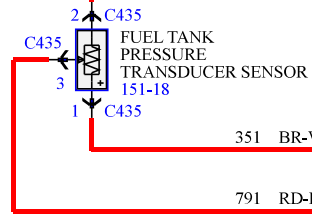
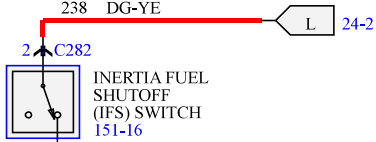

POWERTRAIN  
CONTROL  
MODULE (PCM)  
151-6

